

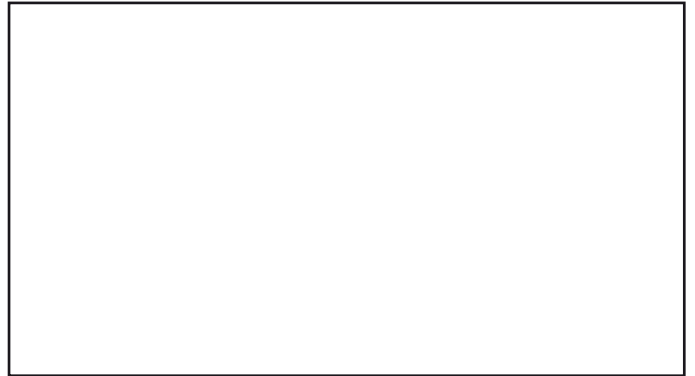

2015



2016



AUTOELEKTRIKA - NÁVĚSY / PŘÍVĚSY

ELECTRIC EQUIPMENT - TRAILERS

ELEKTRISCHE ANLAGE - ANHÄNGER

АВТОЭЛЕКТРИКА - ТРЕЙЛЕРЫ



EUROPOINT I.

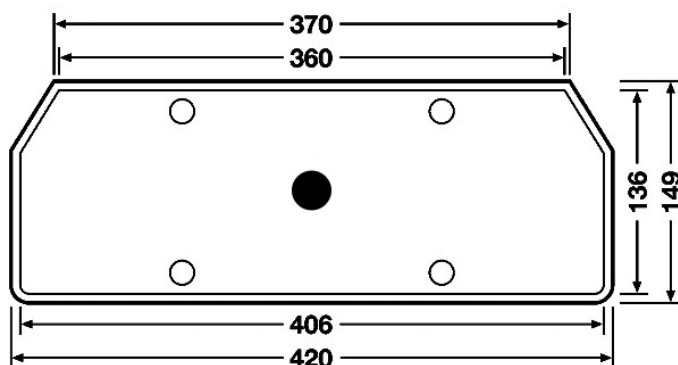

KÓD / ORDER CODE / BESTELL NR. / КОД	OE / OE NUMBER / OE NUMBER / OE	PRAVÁ / RIGHT / RECHTS / ПРАВАЯ	LEVÁ / LEFT / LINKS / ЛЕВАЯ	OSVĚTLENÍ SPZ / ILLUMINATION FOR NUMBERPLATE / KENNZEICHENLEUCHTE / ПОДСВЕТКА НОМЕРНОГО ЗНАКА	PŘIPOJENÍ / CONNECTION / ANSCHLUSS / СОЕДИНЕНИЕ
722632	25-5500-507	●			
722623	25-5100-507		●		
722636 KRYT / LENS / LICHTSCHEIBE / СТЕКЛО ФАРЫ	18-8550-002	●	●		

ŽÁROVKA / BULB / GLÜHLAMPE / ЛАМПОЧКА

722932	4x	P21W 24V, BA15s
722938	1x	P21 5W 24V, BAY15d
722941	2x	R5W 24V, BA15s

EUROPOINT I.

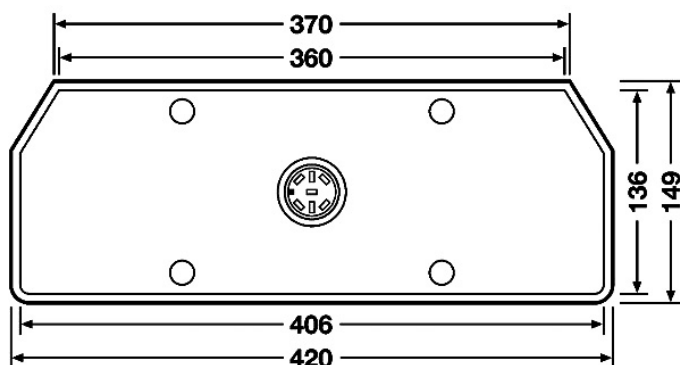

KÓD / ORDER CODE / BESTELL NR. / КОД	OE / OE NUMBER / OE NUMBER / OE	PRAVÁ / RIGHT / RECHTS / ПРАВАЯ	LEVÁ / LEFT / LINKS / ЛЕВАЯ	OSVĚTLENÍ SPZ / ILLUMINATION FOR NUMBERPLATE / KENNZEICHENLEUCHE / ПОДСВЕТКА НОМЕРНОГО ЗНАКА	PŘIPOJENÍ / CONNECTION / ANSCHLUSS / СОЕДИНЕНИЕ
722607	25-5400-507	●			
722615	25-5000-507		●		
722636 KRYT / LENS / LICHTSCHEIBE / СТЕКЛО ФАРЫ	18-8550-002	●	●		

ŽÁROVKA / BULB / GLÜHLAMPE / ЛАМПОЧКА

722932	4x	P21W 24V, BA15s
722938	1x	P21 5W 24V, BAY15d
722941	2x	R5W 24V, BA15s

OPRavnÁ SADA / REPAIR KIT / ANSCHLUSSATZ / РЕМОНТНЫЙ КОМПЛЕКТ

725506	13-5626-951	
---------------	-------------	--

EUROPOINT II.

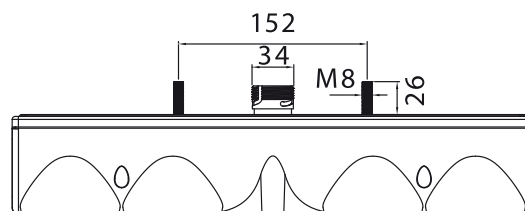
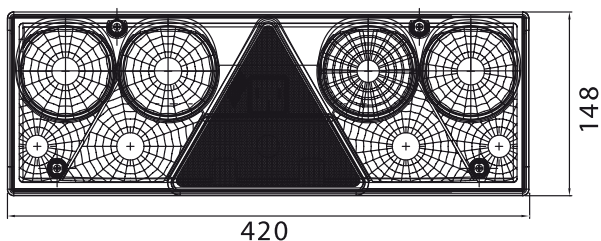

KÓD / ORDER CODE / BESTELL NR. / КОД	OE / OE NUMBER / OE NUMMER / OE	PRAVÁ / RIGHT / RECHTS / ПРАВЯЯ	LEVÁ / LEFT / LINKS / ЛЕВАЯ	OSVĚTLENÍ SPZ / ILLUMINATION FOR NUMBERPLATE / KENNZEICHENLEUCHTE / ПОДСВЕТКА НОМЕРНОГО ЗНАКА	PŘIPOJENÍ / CONNECTION / ANSCHLUSS / СОЕДИНЕНИЕ
722609	25-6400-507	●			
722608	25-6000-507		●		
722610 KRYT / LENS / LICHTSCHEIBE / СТЕКЛО ФАРЫ	18-8560-002	●	●		

ŽÁROVKA / BULB / GLÜHLAMPE / ЛАМПОЧКА

722932	4x	P21W 24V, BA15s
722944	3x	R10W 24V, BA15s
722935	1x	PY21W 24V, BAU15s

OPRavná SADA / REPAIR KIT / ANSCHLUSSATZ / РЕМОНТНЫЙ КОМПЛЕКТ

725506	13-5626-951	
---------------	-------------	--

EUROPOINT II.

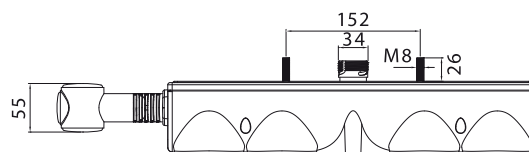
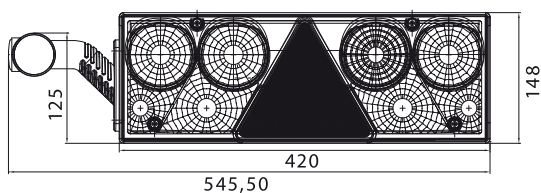

KÓD / ORDER CODE / BESTELL NR. / КОД	OE / OE NUMBER / OE NUMMER / OE	PRAVÁ / RIGHT / RECHTS / ПРАВАЯ	LEVÁ / LEFT / LINKS / ЛЕВАЯ	OSVĚTLENÍ SPZ / ILLUMINATION FOR NUMBERPLATE / KENNZEICHENLEUCHTE / ПОДСВЕТКА НОМЕРНОГО ЗНАКА	PŘIPOJENÍ / CONNECTION / ANSCHLUSS / СОЕДИНЕНИЕ
722602	25-6411-517	●			
722604	25-6011-517		●		
722610 KRYT / LENS / LICHTSCHEIBE / СТЕКЛО ФАРЫ	18-8560-002	●	●		

KÓD / ORDER CODE / BESTELL NR. / КОД		POPIS / DESCRIPTION / BESCHREIBUNG / ОПИСАНИЕ	OE / OE NUMBER / OE NUMBER / OE	NÁKRES / DRAWING / ZEICHNUNG / ЧЕРТЁЖ
725520 PRAVÁ / RIGHT / RECHTS / ПРАВАЯ		ČERVENÁ + BÍLÁ + ORANŽOVÁ, KABEL - 0,1 m / RED + WHITE + ORANGE, CABLE - 0,1 m / ROT + WEISS + ORANGE, KABEL - 0,1 m / КРАСНАЯ + БЕЛАЯ + ОРАНЖЕВАЯ, КАБЕЛЬ - 0,1 м	31-3306-067	
725521 LEVÁ / LEFT / LINKS / ЛЕВАЯ		ČERVENÁ + BÍLÁ + ORANŽOVÁ, KABEL - 0,1 m / RED + WHITE + ORANGE, CABLE - 0,1 m / ROT + WEISS + ORANGE, KABEL - 0,1 m / КРАСНАЯ + БЕЛАЯ + ОРАНЖЕВАЯ, КАБЕЛЬ - 0,1 м	31-3305-067	
				722948 12V T4W 12V, BA9s 722949 24V T4W 24V, BA9s

ŽÁROVKA / BULB / GLÜHLAMPE / ЛАМПОЧКА

722932	4x	P21W 24V, BA15s
722944	3x	R10W 24V, BA15s
722935	1x	PY21W 24V, BAU15s
722949	1x	T4W 24V, BA9s

OPRÁVNÁ SADA / REPAIR KIT / ANSCHLUSSATZ / РЕМОНТНЫЙ КОМПЛЕКТ

725506	13-5626-951	
---------------	-------------	--

EUROPOINT II. – SCHMITZ

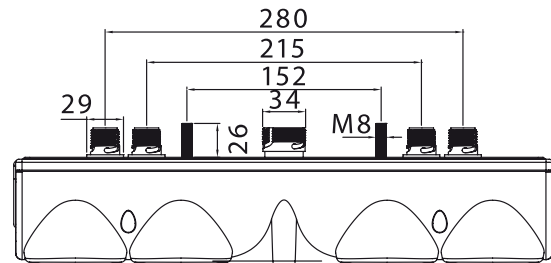
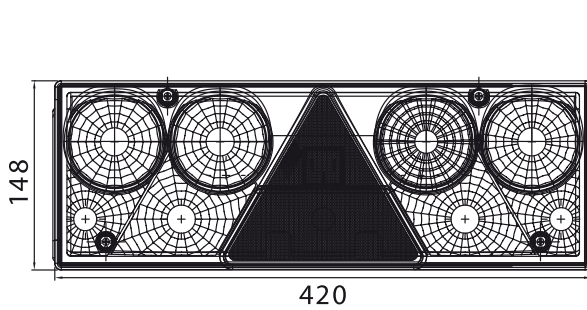

KÓD / ORDER CODE / BESTELL NR. / КОД	OE / OE NUMBER / OE NUMMER / OE	PRAVÁ / RIGHT / RECHTS / ПРАВАЯ	LEVÁ / LEFT / LINKS / ЛЕВАЯ	OSVĚTLENÍ SPZ / ILLUMINATION FOR NUMBERPLATE / KENNZEICHENLEUCHE / ПОДСВЕТКА НОМЕРНОГО ЗНАКА	PŘIPOJENÍ / CONNECTION / ANSCHLUSS / СОЕДИНЕНИЕ
722620	25-6410-507	●			
722619	25-6010-507		●		
722610 KRYT / LENS / LICHTSCHEIBE / СТЕКЛО ФАРЫ	18-8560-002	●	●		

ŽÁROVKA / BULB / GLÜHLAMPE / ЛАМПОЧКА

722932	4x	P21W 24V, BA15s
722944	3x	R10W 24V, BA15s
722935	1x	PY21W 24V, BAU15s

OPRavná SADA / REPAIR KIT / ANSCHLUSSATZ / РЕМОНТНЫЙ КОМПЛЕКТ

725506	13-5626-951	
---------------	-------------	--

EUROPOINT II. – SCHMITZ

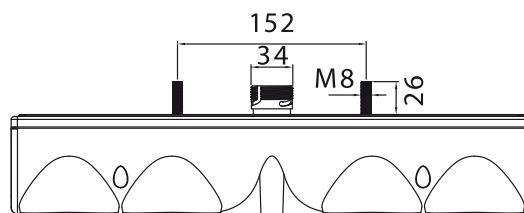
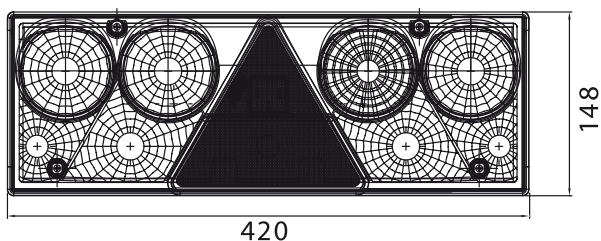

KÓD / ORDER CODE / BESTELL NR. / КОД	OE / OE NUMBER / OE NUMBER / OE	PRAVÁ / RIGHT / RECHTS / ПРАВАЯ	LEVÁ / LEFT / LINKS / ЛЕВАЯ	OSVĚTLENÍ SPZ / ILLUMINATION FOR NUMBERPLATE / KENNZEICHENLEUCHTE / ПОДСВЕТКА НОМЕРНОГО ЗНАКА	PŘIJOJENÍ / CONNECTION / ANSCHLUSS / СОЕДИНЕНИЕ
722630	25-6400-707	●			
722631	25-6000-707		●		
722610 KRYT / LENS / LICHTSCHEIBE / СТЕКЛО ФАРЫ	18-8560-002	●	●		

ŽÁROVKA / BULB / GLÜHLAMPE / ЛАМПОЧКА

722932	4x	P21W 24V, BA15s
722944	3x	R10W 24V, BA15s
722935	1x	PY21W 24V, BAU15s

OPRavná SADA / REPAIR KIT / ANSCHLUSSATZ / РЕМОНТНЫЙ КОМПЛЕКТ

725506	13-5626-951	
---------------	-------------	--

EUROPOINT III.

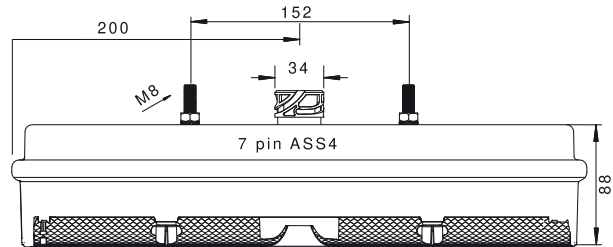
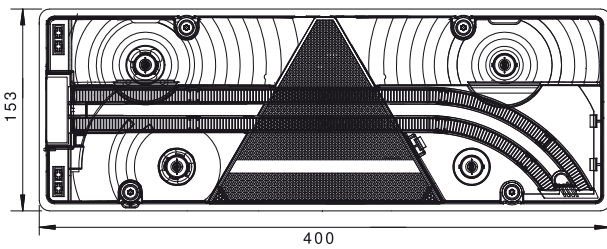

KÓD / ORDER CODE / BESTELL NR. / КОД	OE / OE NUMBER / OE NUMBER / OE	PRAVÁ / RIGHT / RECHTS / ПРАВАЯ	LEVÁ / LEFT / LINKS / ЛЕВАЯ	OSVĚTLENÍ SPZ / ILLUMINATION FOR NUMBERPLATE / KENNZEICHENLEUCHE / ПОДСВЕТКА НОМЕРНОГО ЗНАКА	PŘIPOJENÍ / CONNECTION / ANSCHLUSS / СОЕДИНЕНИЕ
722616	25-7400-507	●			
722617	25-7000-507		●		
722621 KRYT / LENS / LICHTSCHEIBE / СТЕКЛО ФАРЫ	18-8570-101	●			
722622 KRYT / LENS / LICHTSCHEIBE / СТЕКЛО ФАРЫ	18-8570-001		●		
722627 TRUBICE / INSERT „LIGHT GUIDE“ R / EINSATZ „LIGHT GUIDE“ R / СВЕТОДИОДНАЯ ТРУБКА ОСВЕЩЕНИЯ В ФАРАХ ПРАВАЯ	12-1570-101	●			
722628 TRUBICE / INSERT „LIGHT GUIDE“ L / EINSATZ „LIGHT GUIDE“ L / СВЕТОДИОДНАЯ ТРУБКА ОСВЕЩЕНИЯ В ФАРАХ ЛЕВАЯ	12-1570-001		●		

ŽÁROVKA / BULB / GLÜHLAMPE / ЛАМПОЧКА

722932	3x	P21W 24V, BA15s
722935	1x	PY21W 24V, BAU15s

OPRavná SADA / REPAIR KIT / ANSCHLUSSATZ / РЕМОНТНЫЙ КОМПЛЕКТ

725506	13-5626-951	
---------------	-------------	--

EUROPOINT III.

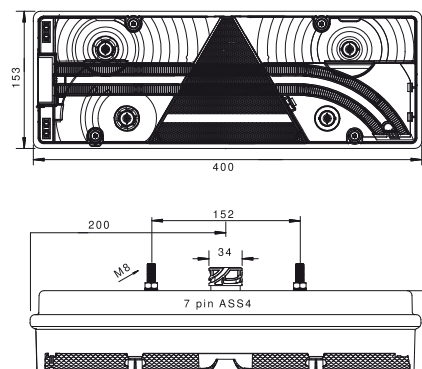

KÓD / ORDER CODE / BESTELL NR. / КОД	OE / OE NUMBER / OE NUMMER / OE	PRAVÁ / RIGHT / RECHTS / ПРАВАЯ	LEVÁ / LEFT / LINKS / ЛЕВАЯ	OSVĚTLENÍ SPZ / ILLUMINATION FOR NUMBERPLATE / KENNZEICHENLEUCHE / ПОДСВЕТКА НОМЕРНОГО ЗНАКА	PŘIPOJENÍ / CONNECTION / ANSCHLUSS / СОЕДИНЕНИЕ
722624	25-7420-507	●			
722625	25-7020-507		●		
722621 KRYT / LENS / LICHTSCHEIBE / СТЕКЛО ФАРЫ	18-8570-101	●			
722622 KRYT / LENS / LICHTSCHEIBE / СТЕКЛО ФАРЫ	18-8570-001		●		
722627 TRUBICE / INSERT „LIGHT GUIDE“ R / EINSATZ „LIGHT GUIDE“ R / СВЕТОДИОДНАЯ ТРУБКА ОСВЕЩЕНИЯ В ФАРАХ ПРАВАЯ	12-1570-101	●			
722628 TRUBICE / INSERT „LIGHT GUIDE“ L / EINSATZ „LIGHT GUIDE“ L / СВЕТОДИОДНАЯ ТРУБКА ОСВЕЩЕНИЯ В ФАРАХ ЛЕВАЯ	12-1570-001		●		

KÓD / ORDER CODE / BESTELL NR. / КОД		POPIS / DESCRIPTION / BESCHREIBUNG / ОПИСАНИЕ	OE / OE NUMBER / OE NUMMER / OE	NÁKRES / DRAWING / ZEICHNUNG / ЧЕРТЁЖ
724203 PRAVÁ / RIGHT / RECHTS / ПРАВАЯ		SUPERPOINT IV.	31-3104-017	
724204 LEVÁ / LEFT / LINKS / ЛЕВАЯ		SUPERPOINT IV.	31-3104-007	
721468		P & R / P & R CLICK / P & R KLICKEN / P & R	4260089	

ŽÁROVKA / BULB / GLÜHLAMPE / ЛАМПОЧКА

722932	3x	P21W 24V, BA15s
722935	1x	PY21W 24V, BAU15s

OPRAVNÁ SADA / REPAIR KIT / ANSCHLUSSATZ / РЕМОНТНЫЙ КОМПЛЕКТ

725506	13-5626-951	
---------------	-------------	--

ECOPOINT I.

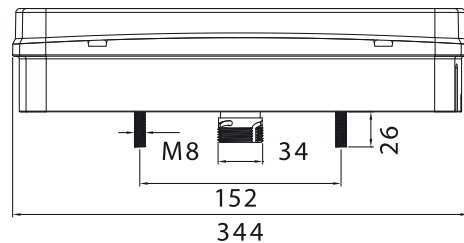
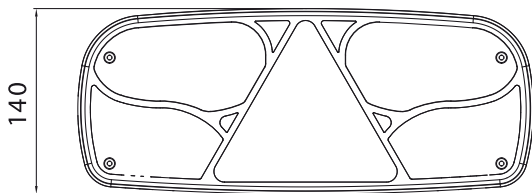

KÓD / ORDER CODE / BESTELL NR. / КОД	OE / OE NUMBER / OE NUMBER / OE	PRAVÁ / RIGHT / RECHTS / ПРАВАЯ	LEVÁ / LEFT / LINKS / ЛЕВАЯ	OSVĚTLENÍ SPZ / ILLUMINATION FOR NUMBERPLATE / KENNZEICHENLEUCHE / ПОДСВЕТКА НОМЕРНОГО ЗНАКА	PŘIPOJENÍ / CONNECTION / ANSCHLUSS / СОЕДИНЕНИЕ
724832	25-2600-007	●			
724833	25-2200-007		●		
724840 KRYT / LENS / LICHTSCHEIBE / СТЕКЛО ФАРЫ	18-8522-002	●	●		

ŽÁROVKA / BULB / GLÜHLAMPE / ЛАМПОЧКА

722932	3x	P21W 24V, BA15s
722938	1x	P21 5W 24V, BAY15d

OPRAVNÁ SADA / REPAIR KIT / ANSCHLUSSATZ / РЕМОНТНЫЙ КОМПЛЕКТ

725506	13-5626-951	
---------------	-------------	--

ECOPOINT I.

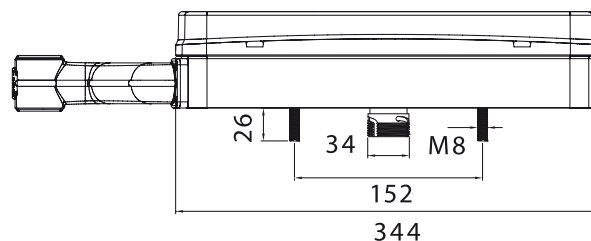
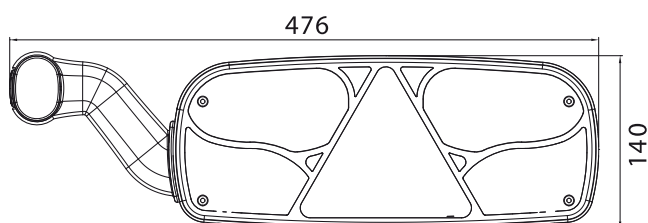

KÓD / ORDER CODE / BESTELL NR. / КОД	OE / OE NUMBER / OE NUMMER / OE	PRAVÁ / RIGHT / RECHTS / ПРАВАЯ	LEVÁ / LEFT / LINKS / ЛЕВАЯ	OSVĚTLENÍ SPZ / ILLUMINATION FOR NUMBERPLATE / KENNZEICHENLEUCHE / ПОДСВЕТКА НОМЕРНОГО ЗНАКА	PŘIPOJENÍ / CONNECTION / ANSCHLUSS / СОЕДИНЕНИЕ
724836	25-2610-007	●			
724835	25-2210-007		●		
724840 KRYT / LENS / LICHTSCHEIBE / СТЕКЛО ФАРЫ	18-8522-002	●	●		

ŽÁROVKA / BULB / GLÜHLAMPE / ЛАМПОЧКА

722932	3x	P21W 24V, BA15s
722938	1x	P21 5W 24V, BAY15d
722949	1x	T4W 24V, BA9s

OPRAVNÁ SADA / REPAIR KIT / ANSCHLUSSATZ / РЕМОНТНЫЙ КОМПЛЕКТ

725506	13-5626-951	
---------------	-------------	--

ECOPOINT I.

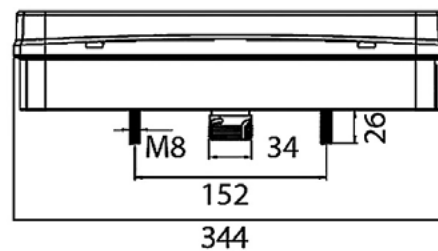
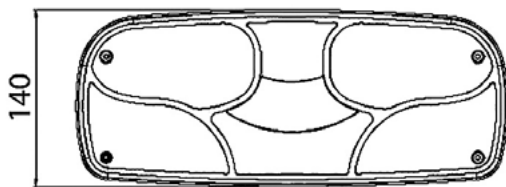

KÓD / ORDER CODE / BESTELL NR. / КОД	OE / OE NUMBER / OE NUMBER / OE	PRAVÁ / RIGHT / RECHTS / ПРАВАЯ	LEVÁ / LEFT / LINKS / ЛЕВАЯ	OSVĚTLENÍ SPZ / ILLUMINATION FOR NUMBERPLATE / KENNZEICHENLEUCHE / ПОДСВЕТКА НОМЕРНОГО ЗНАКА	PŘIPOJENÍ / CONNECTION / ANSCHLUSS / СОЕДИНЕНИЕ
724823	25-2400-507	●			
724831	25-2000-507		●		
724842 KRYT / LENS / LICHTSCHEIBE / СТЕКЛО ФАРЫ	18-8520-002	●	●		

ŽÁROVKA / BULB / GLÜHLAMPE / ЛАМПОЧКА

722932	4x	P21W 24V, BA15s
722941	2x	R5W 24V, BA15s

OPRAVNÁ SADA / REPAIR KIT / ANSCHLUSSATZ / РЕМОНТНЫЙ КОМПЛЕКТ

725506	13-5626-951	
---------------	-------------	--

ECOPOINT I.

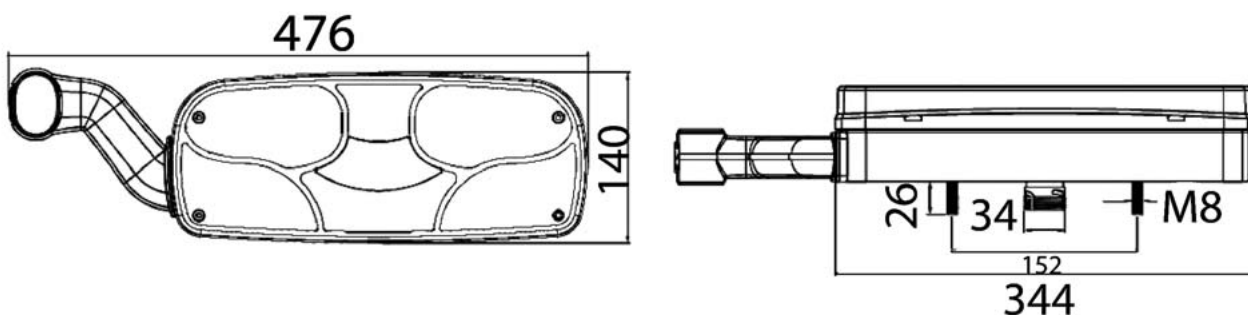

KÓD / ORDER CODE / BESTELL NR. / КОД	OE / OE NUMBER / OE NUMMER / OE	PRAVÁ / RIGHT / RECHTS / ПРАВАЯ	LEVÁ / LEFT / LINKS / ЛЕВАЯ	OSVĚTLENÍ SPZ / ILLUMINATION FOR NUMBERPLATE / KENNZEICHENLEUCHE / ПОДСВЕТКА НОМЕРНОГО ЗНАКА	PŘIPOJENÍ / CONNECTION / ANSCHLUSS / СОЕДИНЕНИЕ
724846	25-2410-507	●			
724847	25-2010-507		●		
724842 KRYT / LENS / LICHTSCHEIBE / СТЕКЛО ФАРЫ	18-8520-002	●	●		

ŽÁROVKA / BULB / GLÜHLAMPE / ЛАМПОЧКА

722932	4x	P21W 24V, BA15s
722941	2x	R5W 24V, BA15s
722949	1x	T4W 24V, BA9s

OPRAVNÁ SADA / REPAIR KIT / ANSCHLUSSATZ / РЕМОНТНЫЙ КОМПЛЕКТ

725506	13-5626-951	
---------------	-------------	--

ECOPOINT II.

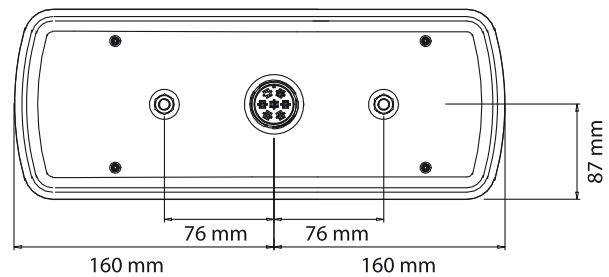
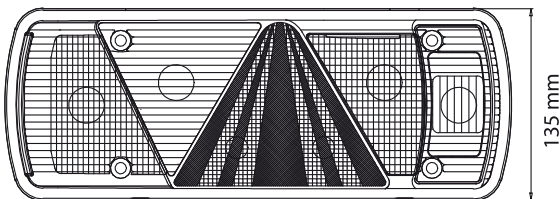

KÓD / ORDER CODE / BESTELL NR. / КОД	OE / OE NUMBER / OE NUMBER / OE	PRAVÁ / RIGHT / RECHTS / ПРАВАЯ	LEVÁ / LEFT / LINKS / ЛЕВАЯ	OSVĚTLENÍ SPZ / ILLUMINATION FOR NUMBERPLATE / KENNZEICHENLEUCHE / ПОДСВЕТКА НОМЕРНОГО ЗНАКА	PŘIPOJENÍ / CONNECTION / ANSCHLUSS / СОЕДИНЕНИЕ
722049	25-2900-507	●			
722050	25-2800-507		●		
722055 KRYT / LENS / LICHTSCHEIBE / СТЕКЛО ФАРЫ	18-8529-002	●			
722056 KRYT / LENS / LICHTSCHEIBE / СТЕКЛО ФАРЫ	18-8528-002		●		

ŽÁROVKA / BULB / GLÜHLAMPE / ЛАМПОЧКА

722932	3x	P21W 24V, BA15s
722935	1x	PY21W 24V, BAU15s
722944	2x	R10W 24V, BA15s

OPRavná SADA / REPAIR KIT / ANSCHLUSSATZ / РЕМОУННЫЙ КОМПЛЕКТ

725506	13-5626-951	
---------------	-------------	--

ECOPOINT II.

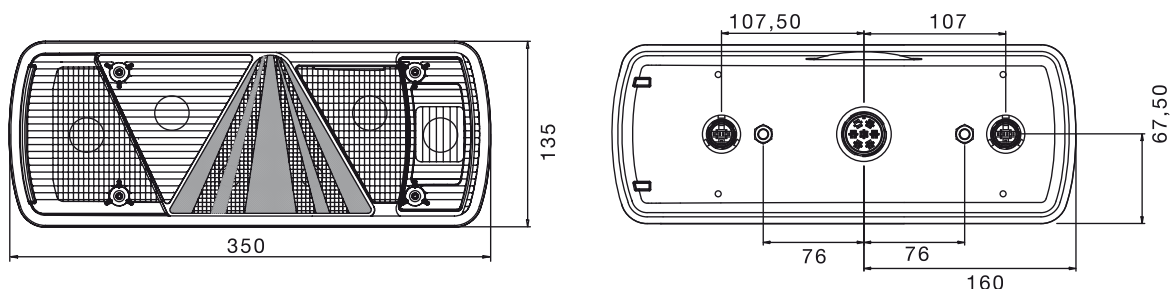

KÓD / ORDER CODE / BESTELL NR. / КОД	OE / OE NUMBER / OE NUMBER / OE	PRAVÁ / RIGHT / RECHTS / ПРАВАЯ	LEVÁ / LEFT / LINKS / ЛЕВАЯ	OSVĚTLENÍ SPZ / ILLUMINATION FOR NUMBERPLATE / KENNZEICHENLEUCHTE / ПОДСВЕТКА НОМЕРНОГО ЗНАКА	PŘIPOJENÍ / CONNECTION / ANSCHLUSS / СОЕДИНЕНИЕ
722036	25-2900-517	●			
722037	25-2800-517		●		
722055 KRYT / LENS / LICHTSCHEIBE / СТЕКЛО ФАРЫ	18-8529-002	●			
722056 KRYT / LENS / LICHTSCHEIBE / СТЕКЛО ФАРЫ	18-8528-002		●		

ŽÁROVKA / BULB / GLÜHLAMPE / ЛАМПОЧКА

722932	3x	P21W 24V, BA15s
722935	1x	PY21W 24V, BAU15s
722944	2x	R10W 24V, BA15s

OPRavná SADA / REPAIR KIT / ANSCHLUSSATZ / РЕМОУНТНЫЙ КОМПЛЕКТ

725506	13-5626-951	
---------------	-------------	--

ECOPOINT II.

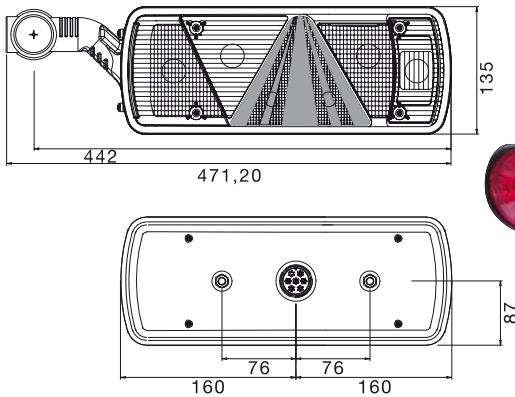

KÓD / ORDER CODE / BESTELL NR. / КОД	OE / OE NUMBER / OE NUMBER / OE	PRAVÁ / RIGHT / RECHTS / ПРАВАЯ	LEVÁ / LEFT / LINKS / ЛЕВАЯ	OSVĚTLENÍ SPZ / ILLUMINATION FOR NUMBERPLATE / KENNZEICHENLEUCHTE / ПОДСВЕТКА НОМЕРНОГО ЗНАКА	PŘIPOJENÍ / CONNECTION / ANSCHLUSS / СОЕДИНЕНИЕ
722051	25-2910-507	●			
722052	25-2810-507		●		
722055 KRYT / LENS / LICHTSCHEIBE / СТЕКЛО ФАРЫ	18-8529-002	●			
722056 KRYT / LENS / LICHTSCHEIBE / СТЕКЛО ФАРЫ	18-8528-002		●		

KÓD / ORDER CODE / BESTELL NR. / КОД		POPIS / DESCRIPTION / BESCHREIBUNG / ОПИСАНИЕ	OE / OE NUMBER / OE NUMBER / OE	NÁKRES / DRAWING / ZEICHNUNG / ЧЕРТЁЖ
725523 PRAVÁ / RIGHT / RECHTS / ПРАВАЯ		ČERVENÁ + BÍLÁ + ORANŽOVÁ, KABEL - 0,1 m / RED + WHITE + ORANGE, CABLE - 0,1 m / ROT + WEISS + ORANGE, KABEL - 0,1 m / КРАСНАЯ + БЕЛАЯ + ОРАНЖЕВАЯ, КАБЕЛЬ - 0,1 м	31-3302-027	
725522 LEVÁ / LEFT / LINKS / ЛЕВАЯ		ČERVENÁ + BÍLÁ + ORANŽOVÁ, KABEL - 0,1 m / RED + WHITE + ORANGE, CABLE - 0,1 m / ROT + WEISS + ORANGE, KABEL - 0,1 m / КРАСНАЯ + БЕЛАЯ + ОРАНЖЕВАЯ, КАБЕЛЬ - 0,1 м	31-3303-027	
				722948 12V T4W 12V, BA9s 722949 24V T4W 24V, BA9s

ŽÁROVKA / BULB / GLÜHLAMPE / ЛАМПОЧКА

722932	3x	P21W 24V, BA15s
722935	1x	PY21W 24V, BAU15s
722944	2x	R10W 24V, BA15s
722949	1x	T4W 24V, BA9s

OPRÁVNÁ SADA / REPAIR KIT / ANSCHLUSSATZ / РЕМОНТНЫЙ КОМПЛЕКТ

725506	13-5626-951	
---------------	-------------	--

ECOPOINT II.

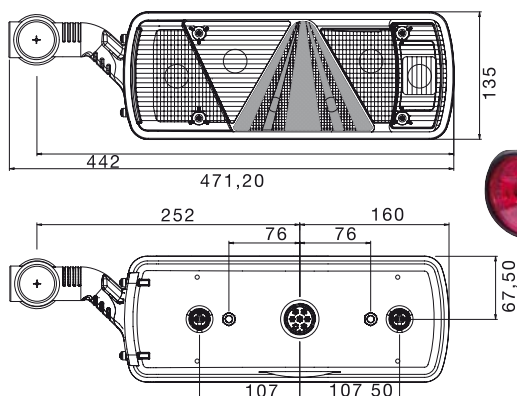

KÓD / ORDER CODE / BESTELL NR. / КОД	OE / OE NUMBER / OE NUMBER / OE	PRAVÁ / RIGHT / RECHTS / ПРАВАЯ	LEVÁ / LEFT / LINKS / ЛЕВАЯ	OSVĚTLENÍ SPZ / ILLUMINATION FOR NUMBERPLATE / KENNZEICHENLEUCHE / ПОДСВЕТКА НОМЕРНОГО ЗНАКА	PŘIPOJENÍ / CONNECTION / ANSCHLUSS / СОЕДИНЕНИЕ
722038	25-2910-517	●			
722039	25-2810-517		●		
722055 KRYT / LENS / LICHTSCHEIBE / СТЕКЛО ФАРЫ	18-8529-002	●			
722056 KRYT / LENS / LICHTSCHEIBE / СТЕКЛО ФАРЫ	18-8528-002		●		

KÓD / ORDER CODE / BESTELL NR. / КОД		POPIS / DESCRIPTION / BESCHREIBUNG / ОПИСАНИЕ	OE / OE NUMBER / OE NUMBER / OE	NÁKRES / DRAWING / ZEICHNUNG / ЧЕРТЁЖ
725523 PRAVÁ / RIGHT / RECHTS / ПРАВАЯ		ČERVENÁ + BÍLÁ + ORANŽOVÁ, KABEL - 0,1 m / RED + WHITE + ORANGE, CABLE - 0,1 m / ROT + WEISS + ORANGE, KABEL - 0,1 m / КРАСНАЯ + БЕЛАЯ + ОРАНЖЕВАЯ, КАБЕЛЬ - 0,1 м	31-3302-027	
725522 LEVÁ / LEFT / LINKS / ЛЕВАЯ		ČERVENÁ + BÍLÁ + ORANŽOVÁ, KABEL - 0,1 m / RED + WHITE + ORANGE, CABLE - 0,1 m / ROT + WEISS + ORANGE, KABEL - 0,1 m / КРАСНАЯ + БЕЛАЯ + ОРАНЖЕВАЯ, КАБЕЛЬ - 0,1 м	31-3303-027	
				722948 12V T4W 12V, BA9s 722949 24V T4W 24V, BA9s

ŽÁROVKA / BULB / GLÜHLAMPE / ЛАМПОЧКА

722932	3x	P21W 24V, BA15s
722935	1x	PY21W 24V, BAU15s
722944	2x	R10W 24V, BA15s
722949	1x	T4W 24V, BA9s

OPRavná SADA / REPAIR KIT / ANSCHLUSSATZ / РЕМОНТНЫЙ КОМПЛЕКТ

725506	13-5626-951	
---------------	-------------	--

ECOPOINT II. - KÖGEL

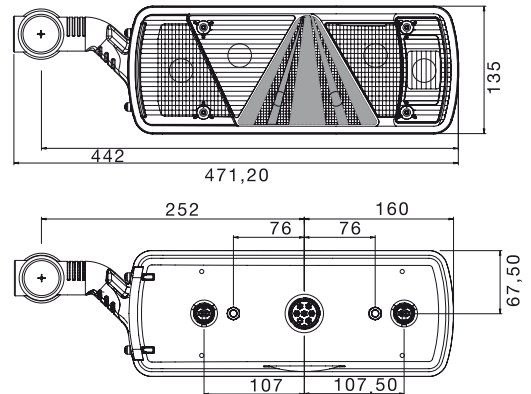

KÓD / ORDER CODE / BESTELL NR. / КОД	OE / OE NUMBER / OE NUMBER / OE	PRAVÁ / RIGHT / RECHTS / ПРАВАЯ	LEVÁ / LEFT / LINKS / ЛЕВАЯ	OSVĚTLENÍ SPZ / ILLUMINATION FOR NUMBERPLATE / KENNZEICHENLEUCHE / ПОДСВЕТКА НОМЕРНОГО ЗНАКА	PŘIPOJENÍ / CONNECTION / ANSCHLUSS / СОЕДИНЕНИЕ
724867	25-2950-517	●			
724866	25-2850-517		●		
724869 KRYT / LENS / LICHTSCHEIBE / СТЕКЛО ФАРЫ	18-8529-502	●			
724868 KRYT / LENS / LICHTSCHEIBE / СТЕКЛО ФАРЫ	18-8528-502		●		

KÓD / ORDER CODE / BESTELL NR. / КОД		POPIS / DESCRIPTION / BESCHREIBUNG / ОПИСАНИЕ	OE / OE NUMBER / OE NUMBER / OE	NÁKRES / DRAWING / ZEICHNUNG / ЧЕРТЁЖ
725505 PRAVÁ / RIGHT / RECHTS / ПРАВАЯ		ČERVENÁ + BÍLÁ + ORANŽOVÁ, KABEL - 0,1 m / RED + WHITE + ORANGE, CABLE - 0,1 m / ROT + WEISS + ORANGE, KABEL - 0,1 m / КРАСНАЯ + БЕЛАЯ + ОРАНЖЕВАЯ, КАБЕЛЬ - 0,1 м	31-3302-037	
725504 LEVÁ / LEFT / LINKS / ЛЕВАЯ		ČERVENÁ + BÍLÁ + ORANŽOVÁ, KABEL - 0,1 m / RED + WHITE + ORANGE, CABLE - 0,1 m / ROT + WEISS + ORANGE, KABEL - 0,1 m / КРАСНАЯ + БЕЛАЯ + ОРАНЖЕВАЯ, КАБЕЛЬ - 0,1 м	31-3303-037	
				722948 12V T4W 12V, BA9s 722949 24V T4W 24V, BA9s

ŽÁROVKA / BULB / GLÜHLAMPE / ЛАМПОЧКА

722932	3x	P21W 24V, BA15s
722935	1x	PY21W 24V, BAU15s
722944	2x	R10W 24V, BA15s
722949	1x	T4W 24V, BA9s

OPRÁVNÁ SADA / REPAIR KIT / ANSCHLUSSATZ / РЕМОНТНЫЙ КОМПЛЕКТ

725506	13-5626-951	
---------------	-------------	--

EARPOINT I.

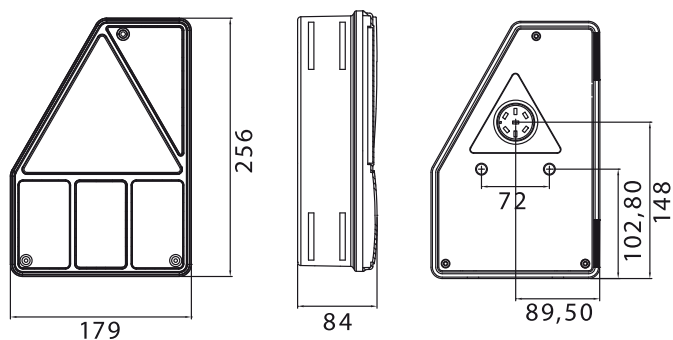

KÓD / ORDER CODE / BESTELL NR. / КОД	OE / OE NUMBER / OE NUMBER / OE	PRAVÁ / RIGHT / RECHTS / ПРАВАЯ	LEVÁ / LEFT / LINKS / ЛЕВАЯ	OSVĚTLENÍ SPZ / ILLUMINATION FOR NUMBERPLATE / KENNZEICHENLEUCHTE / ПОДСВЕТКА НОМЕРНОГО ЗНАКА	PŘIJOJENÍ / CONNECTION / ANSCHLUSS / СОЕДИНЕНИЕ
723971	24-4301-007	●			
723979	24-4101-007		●		
724864 KRYT / LENS / LICHTSCHEIBE / СТЕКЛО ФАРЫ	18-8442-007	●			
724863 KRYT / LENS / LICHTSCHEIBE / СТЕКЛО ФАРЫ	18-8440-007		●		

ŽÁROVKA / BULB / GLÜHLAMPE / ЛАМПОЧКА

722932	3x	P21W 24V, BA15s
722944	1x	R10W 24V, BA15s

OPRavná SADA / REPAIR KIT / ANSCHLUSSATZ / РЕМОНТНЫЙ КОМПЛЕКТ

725506	13-5626-951	
---------------	-------------	--

EARPOINT I.

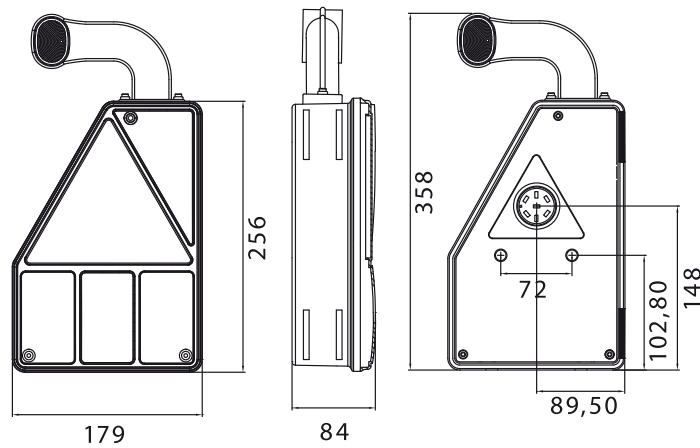

KÓD / ORDER CODE / BESTELL NR. / КОД	OE / OE NUMBER / OE NUMBER / OE	PRAVÁ / RIGHT / RECHTS / ПРАВАЯ	LEVÁ / LEFT / LINKS / ЛЕВАЯ	OSVĚTLENÍ SPZ / ILLUMINATION FOR NUMBERPLATE / KENNZEICHENLEUCHTE / ПОДСВЕТКА НОМЕРНОГО ЗНАКА	PŘIPOJENÍ / CONNECTION / ANSCHLUSS / СОЕДИНЕНИЕ
723980	24-4351-007	●			
723981	24-4151-007		●		
724864 KRYT / LENS / LICHTSCHEIBE / СТЕКЛО ФАРЫ	18-8442-007	●			
724863 KRYT / LENS / LICHTSCHEIBE / СТЕКЛО ФАРЫ	18-8440-007		●		

ŽÁROVKA / BULB / GLÜHLAMPE / ЛАМПОЧКА

722932	3x	P21W 24V, BA15s
722944	1x	R10W 24V, BA15s
722949	1x	T4W 24V, BA9s

OPRavná SADA / REPAIR KIT / ANSCHLUSSATZ / РЕМОУНТНЫЙ КОМПЛЕКТ

725506	13-5626-951	
---------------	-------------	--

LAMBERET

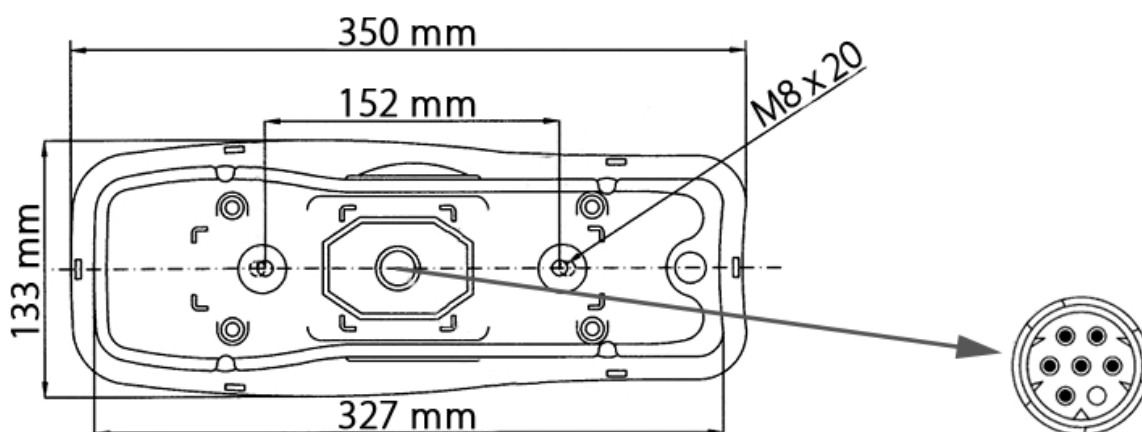

KÓD / ORDER CODE / BESTELL NR. / КОД	OE / OE NUMBER / OE NUMBER / OE	PRAVÁ / RIGHT / RECHTS / ПРАВАЯ	LEVÁ / LEFT / LINKS / ЛЕВАЯ	OSVĚTLENÍ SPZ / ILLUMINATION FOR NUMBERPLATE / KENNZEICHENLEUCHE / ПОДСВЕТКА НОМЕРНОГО ЗНАКА	PŘIPOJENÍ / CONNECTION / ANSCHLUSS / СОЕДИНЕНИЕ
721568	153010	●			
721567	153000		●		
721569	153020		●	●	
721571 KRYT / LENS / LICHTSCHEIBE / СТЕКЛО ФАРЫ	053710	●			
721570 KRYT / LENS / LICHTSCHEIBE / СТЕКЛО ФАРЫ	053700		●		

ŽÁROVKA / BULB / GLÜHLAMPE / ЛАМПОЧКА

722932	4x	P21W 24V, BA15s
722941	2x	R5W 24V, BA15s

OPRAVNÁ SADA / REPAIR KIT / ANSCHLUSSATZ / РЕМОНТНЫЙ КОМПЛЕКТ

721493	
---------------	--

LAMBERET

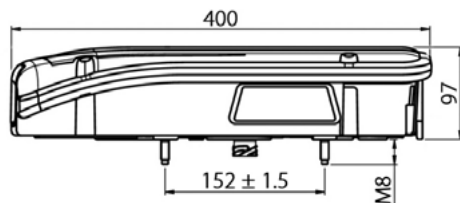

KÓD / ORDER CODE / BESTELL NR. / КОД	OE / OE NUMBER / OE NUMBER / OE	PRAVÁ / RIGHT / RECHTS / ПРАВАЯ	LEVÁ / LEFT / LINKS / ЛЕВАЯ	OSVĚTLENÍ SPZ / ILLUMINATION FOR NUMBERPLATE / KENNZEICHENLEUCHE / ПОДСВЕТКА НОМЕРНОГО ЗНАКА	PŘIPOJENÍ / CONNECTION / ANSCHLUSS / СОЕДИНЕНИЕ
721551	156050	●			
721550	156040		●		
721549	156060		●	●	
721553 KRYT / LENS / LICHTSCHEIBE / СТЕКЛО ФАРЫ	056710	●			
721552 KRYT / LENS / LICHTSCHEIBE / СТЕКЛО ФАРЫ	056700		●		

KÓD / ORDER CODE / BESTELL NR. / КОД	OE / OE NUMBER / OE NUMBER / OE	PRAVÁ / RIGHT / RECHTS / ПРАВАЯ	LEVÁ / LEFT / LINKS / ЛЕВАЯ	PŘIPOJENÍ / CONNECTION / ANSCHLUSS / СОЕДИНЕНИЕ
1 721737	D13035	●		
1 721738	D13034		●	
1 721731	D12711	●		
1 721732	D12712		●	

KÓD / ORDER CODE / BESTELL NR. / КОД	POPIS / DESCRIPTION / BESCHREIBUNG / ОПИСАНИЕ	OE / OE NUMBER / OE NUMBER / OE	PŘIPOJENÍ / CONNECTION / ANSCHLUSS / СОЕДИНЕНИЕ
720490	PODLŮŽKA / SPACER / ABSTANDHALTER / РАСПОРКА	001846	

ŽÁROVKA / BULB / GLÜHLAMPE / ЛАМПОЧКА

722932	3x	P21W 24V, BA15s
722941	3x	R5W 24V, BA15s
722935	1x	PY21W 24V, BAU15s

OPRavná SADA / REPAIR KIT / ANSCHLUSSATZ / РЕМОНТНЫЙ КОМПЛЕКТ

721481	
---------------	--

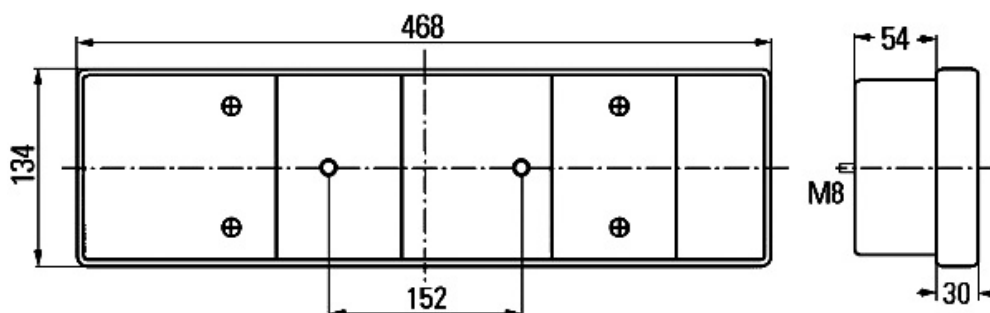

KÓD / ORDER CODE / BESTELL NR. / КОД	OE / OE NUMBER / OE NUMBER / OE	PRAVÁ / RIGHT / RECHTS / ПРАВАЯ	LEVÁ / LEFT / LINKS / ЛЕВАЯ	OSVĚTLENÍ SPZ / ILLUMINATION FOR NUMBERPLATE / KENNZEICHENLEUCHTE / ПОДСВЕТКА НОМЕРНОГО ЗНАКА	PŘIPOJENÍ / CONNECTION / ANSCHLUSS / СОЕДИНЕНИЕ
720251		•			
720252			•		
722716 KRYT / LENS / LICHTSCHEIBE / СТЕКЛО ФАРЫ		•			
722718 KRYT / LENS / LICHTSCHEIBE / СТЕКЛО ФАРЫ			•		

ŽÁROVKA / BULB / GLÜHLAMPE / ЛАМПОЧКА

722932	4x	P21W 24V, BA15s
722944	3x	R10W 24V, BA15s

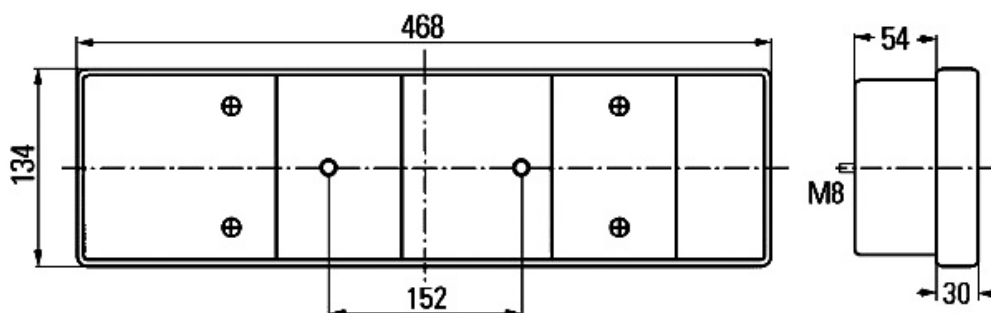

KÓD / ORDER CODE / BESTELL NR. / КОД	OE / OE NUMBER / OE NUMBER / OE	PRAVÁ / RIGHT / RECHTS / ПРАВАЯ	LEVÁ / LEFT / LINKS / ЛЕВАЯ	OSVĚTLENÍ SPZ / ILLUMINATION FOR NUMBERPLATE / KENNZEICHENLEUCHE / ПОДСВЕТКА НОМЕРНОГО ЗНАКА	PŘIPOJENÍ / CONNECTION / ANSCHLUSS / СОЕДИНЕНИЕ
722060		●			
722061			●	●	
722063 KRYT / LENS / LICHTSCHEIBE / СТЕКЛО ФАРЫ	9EL152889-001	●	●		

ŽÁROVKA / BULB / GLÜHLAMPE / ЛАМПОЧКА

722932	4x	P21W 24V, BA15s
722944	3x	R10W 24V, BA15s

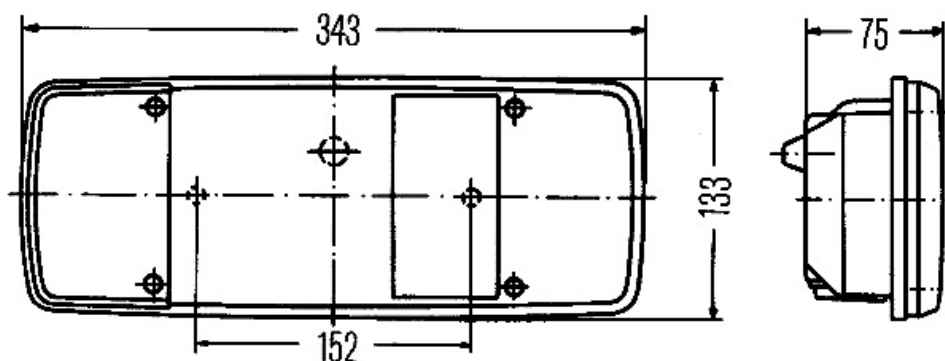

KÓD / ORDER CODE / BESTELL NR. / КОД	OE / OE NUMBER / OE NUMBER / OE	PRAVÁ / RIGHT / RECHTS / ПРАВАЯ	LEVÁ / LEFT / LINKS / ЛЕВАЯ	OSVĚTLENÍ SPZ / ILLUMINATION FOR NUMBERPLATE / KENNZEICHENLEUCHE / ПОДСВЕТКА НОМЕРНОГО ЗНАКА	PŘIPOJENÍ / CONNECTION / ANSCHLUSS / СОЕДИНЕНИЕ
720247	2VP003567-121	●			
720248	2VP003567-111		●	●	
720249 <small>KRYT / LENS / LICHTSCHEIBE / СТЕКЛО ФАРЫ</small>	9EL122689-021	●	●		

ŽÁROVKA / BULB / GLÜHLAMPE / ЛАМПОЧКА

722932	4x	P21W 24V, BA15s
722944	2x	R10W 24V, BA15s

KRONE / SCHMITZ

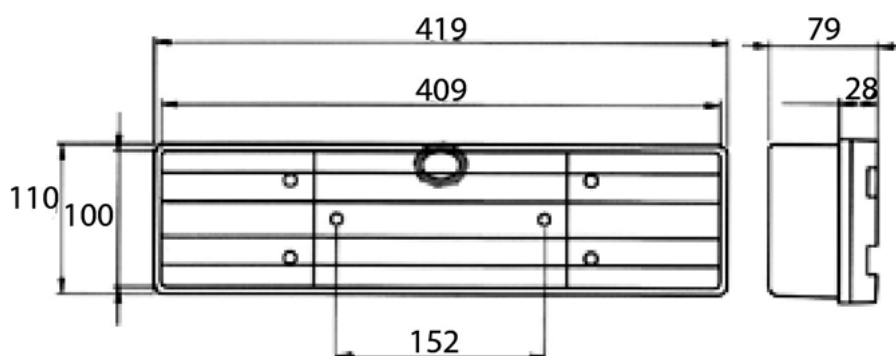

KÓD / ORDER CODE / BESTELL NR. / КОД	OE / OE NUMBER / OE NUMBER / OE	PRAVÁ / RIGHT / RECHTS / ПРАВАЯ	LEVÁ / LEFT / LINKS / ЛЕВАЯ	OSVĚTLENÍ SPZ / ILLUMINATION FOR NUMBERPLATE / KENNZEICHENLEUCHTE / ПОДСВЕТКА НОМЕРНОГО ЗНАКА	ZPÁTEČKA / REVERSING LAMP / RÜCKFAHRLEUCHTE / ФОНАРЬ ЗАДНЕГО ХОДА	MLHOVKA / REAR FOG LAMP / NEBEL / ПРОТИВОТУМАННАЯ ФАРА
722004	2VP004887-021	●			●	
722005	2VA004887-031		●			●
722003	2VB004887-011		●	●		●
722006 KRYT / LENS / LICHTSCHEIBE / СТЕКЛО ФАРЫ	9EL131420-011	●			●	
722008 KRYT / LENS / LICHTSCHEIBE / СТЕКЛО ФАРЫ	9EL131420-001		●			●

ŽÁROVKA / BULB / GLÜHLAMPE / ЛАМПОЧКА

722932	3x	P21W 24V, BA15s
722944	2x	R10W 24V, BA15s

PŘIPOJENÍ / CONNECTION /
ANSCHLUSS / СОЕДИНЕНИЕ



KÖGEL / SCHMITZ

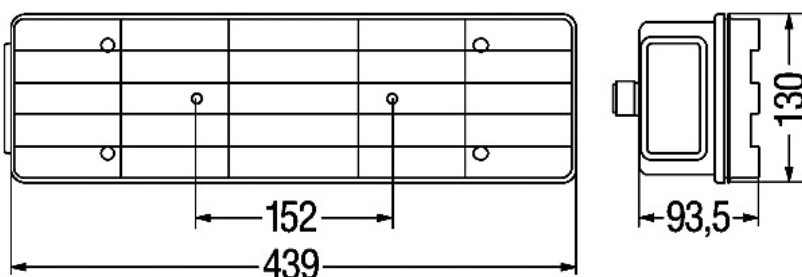

KÓD / ORDER CODE / BESTELL NR. / КОД	OE / OE NUMBER / OE NUMBER / OE	PRAVÁ / RIGHT / RECHTS / ПРАВАЯ	LEVÁ / LEFT / LINKS / ЛЕВАЯ	OSVĚTLENÍ SPZ / ILLUMINATION FOR NUMBERPLATE / KENNZEICHENLEUCHTE / ПОДСВЕТКА НОМЕРНОГО ЗНАКА	PŘIPOJENÍ / CONNECTION / ANSCHLUSS / СОЕДИНЕНИЕ
727362		●			
727363			●		
727366 KRYT / LENS / LICHTSCHEIBE / СТЕКЛО ФАРЫ	9EL340201-001	●	●		

ŽÁROVKA / BULB / GLÜHLAMPE / ЛАМПОЧКА

722932	4x	P21W 24V, BA15s
722941	2x	R5W 24V, BA15s

KÖGEL / SCHMITZ

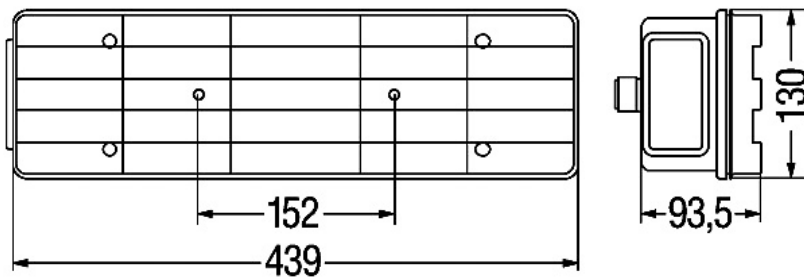

KÓD / ORDER CODE / BESTELL NR. / КОД	OE / OE NUMBER / OE NUMBER / OE	PRAVÁ / RIGHT / RECHTS / ПРАВАЯ	LEVÁ / LEFT / LINKS / ЛЕВАЯ	OSVĚTLENÍ SPZ / ILLUMINATION FOR NUMBERPLATE / KENNZEICHENLEUCHTE / ПОДСВЕТКА НОМЕРНОГО ЗНАКА	PŘIPOJENÍ / CONNECTION / ANSCHLUSS / СОЕДИНЕНИЕ
727364		●			
727365			●		
727366 KRYT / LENS / LICHTSCHEIBE / СТЕКЛО ФАРЫ	9EL340201-001	●	●		

ŽÁROVKA / BULB / GLÜHLAMPE / ЛАМПОЧКА

722932	4x	P21W 24V, BA15s
722941	2x	R5W 24V, BA15s

OPRavnÁ SADA / REPAIR KIT / ANSCHLUSSATZ / РЕМОНТНЫЙ КОМПЛЕКТ

721493	
---------------	--

KÖGEL / SCHMITZ

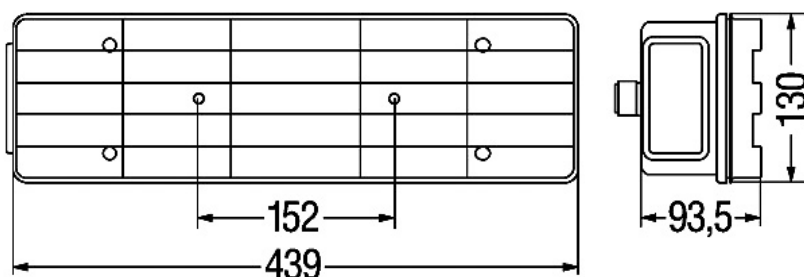

KÓD / ORDER CODE / BESTELL NR. / КОД	OE / OE NUMBER / OE NUMBER / OE	PRAVÁ / RIGHT / RECHTS / ПРАВАЯ	LEVÁ / LEFT / LINKS / ЛЕВАЯ	OSVĚTLENÍ SPZ / ILLUMINATION FOR NUMBERPLATE / KENNZEICHENLEUCHTE / ПОДСВЕТКА НОМЕРНОГО ЗНАКА	PŘIJOJENÍ / CONNECTION / ANSCHLUSS / СОЕДИНЕНИЕ
720072	2SK340101-011	●	●		KABEL / CABLE / КАБЕЛ / КАБЕЛЬ - 0,14m
727366 KRYT / LENS / LICHTSCHEIBE / СТЕКЛО ФАРЫ	9EL340201-001	●	●		

ŽÁROVKA / BULB / GLÜHLAMPE / ЛАМПОЧКА

722932	4x	P21W 24V, BA15s
722941	2x	R5W 24V, BA15s

KÖGEL / SCHMITZ

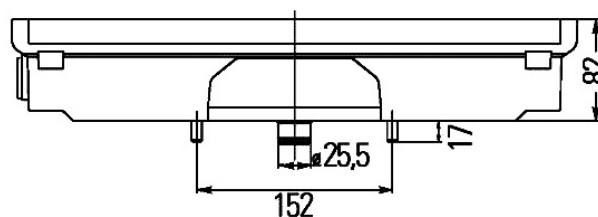
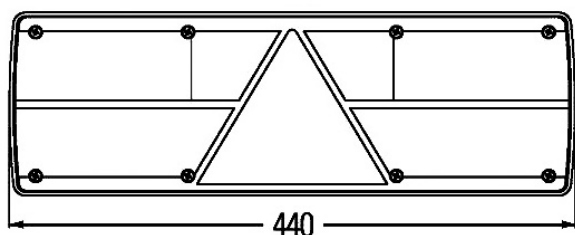

KÓD / ORDER CODE / BESTELL NR. / КОД	OE / OE NUMBER / OE NUMBER / OE	PRAVÁ / RIGHT / RECHTS / ПРАВАЯ	LEVÁ / LEFT / LINKS / ЛЕВАЯ	OSVĚTLENÍ SPZ / ILLUMINATION FOR NUMBERPLATE / KENNZEICHENLEUCHTE / ПОДСВЕТКА НОМЕРНОГО ЗНАКА	PŘIPOJENÍ / CONNECTION / ANSCHLUSS / СОЕДИНЕНИЕ
720351	2VP340450-141	●			KABEL / CABLE / КАБЕЛЬ / КАБЕЛЬ - 0,17m
720350	2VP340450-151		●		
720063 KRYT / LENS / LICHTSCHEIBE / СТЕКЛО ФАРЫ	9EL340208-021	●	●		

ŽÁROVKA / BULB / GLÜHLAMPE / ЛАМПОЧКА

722932	4x	P21W 24V, BA15s
722941	2x	R5W 24V, BA15s
722944	1x	R10W 24V, BA15s

KÖGEL / SCHMITZ

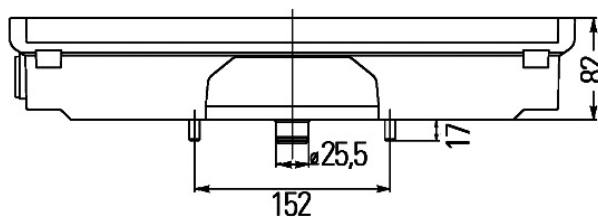
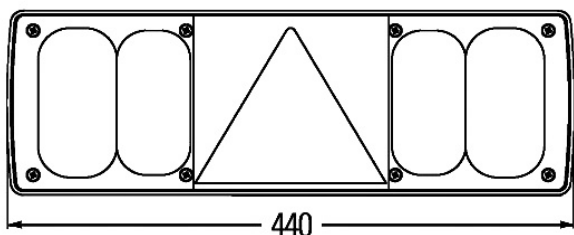

KÓD / ORDER CODE / BESTELL NR. / КОД	OE / OE NUMBER / OE NUMBER / OE	PRAVÁ / RIGHT / RECHTS / ПРАВАЯ	LEVÁ / LEFT / LINKS / ЛЕВАЯ	OSVĚTLENÍ SPZ / ILLUMINATION FOR NUMBERPLATE / KENNZEICHENLEUCHE / ПОДСВЕТКА НОМЕРНОГО ЗНАКА	PŘIPOJENÍ / CONNECTION / ANSCHLUSS / СОЕДИНЕНИЕ
720354	2VP340450-021	●			
720353	2VP340450-031		●		
720355 KRYT / LENS / LICHTSCHEIBE / СТЕКЛО ФАРЫ	9EL340208-001	●	●		

ŽÁROVKA / BULB / GLÜHLAMPE / ЛАМПОЧКА

722944	1x	R10W 24V, BA15s
722932	4x	P21W 24V, BA15s
722941	2x	R5W 24V, BA15s

EASYCONN I.

PRŮHLEDNÝ TROJÚHELNÍK / TRANSPARENT TRIANGLE / DREIECKRÜCKSTRAHLER / СВЕТООТРАЖАЮЩИЙ ТРЕУГОЛЬНИК

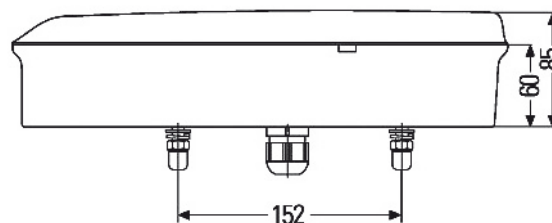
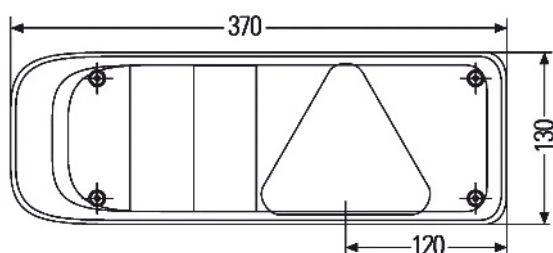
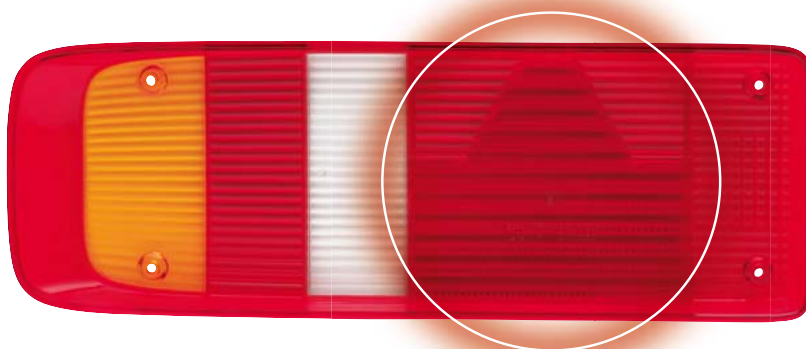

KÓD / ORDER CODE / BESTELL NR. / КОД	OE / OE NUMBER / OE NUMBER / OE	PRAVÁ / RIGHT / RECHTS / ПРАВАЯ	LEVÁ / LEFT / LINKS / ЛЕВАЯ	OSVĚTLENÍ SPZ / ILLUMINATION FOR NUMBERPLATE / KENNZEICHENLEUCHTE / ПОДСВЕТКА НОМЕРНОГО ЗНАКА	PŘIPOJENÍ / CONNECTION / ANSCHLUSS / СОЕДИНЕНИЕ
721166	2VP340931-001	●			
721167	2VP340931-011		●		
721164 KRYT / LENS / LICHTSCHEIBE / СТЕКЛО ФАРЫ	9EL340829-021	●			
721165 KRYT / LENS / LICHTSCHEIBE / СТЕКЛО ФАРЫ	9EL340829-031		●		

ŽÁROVKA / BULB / GLÜHLAMPE / ЛАМПОЧКА

722932	4x	P21W 24V, BA15s
722944	2x	R10W 24V, BA15s

EASYCONN I.

PRŮHLEDNÝ TROJÚHELNÍK / TRANSPARENT TRIANGLE / DREIECKRÜCKSTRAHLER / СВЕТООТРАЖАЮЩИЙ ТРЕУГОЛЬНИК

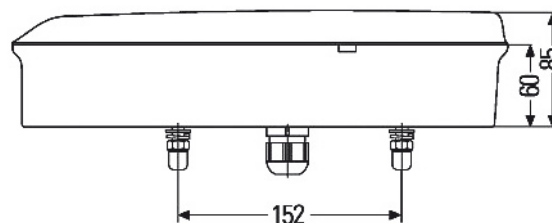
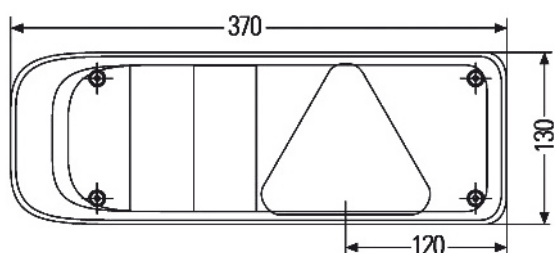
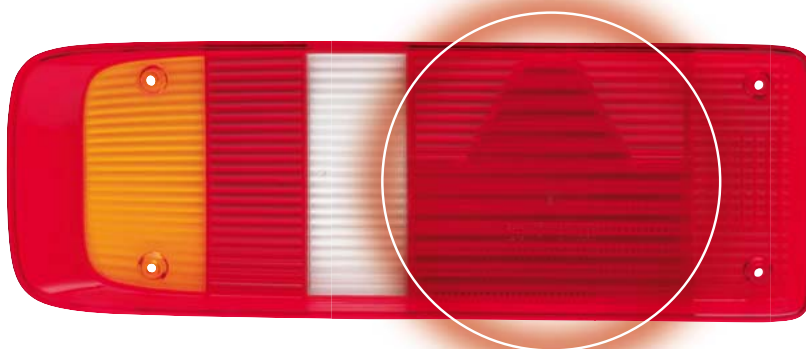

KÓD / ORDER CODE / BESTELL NR. / КОД	OE / OE NUMBER / OE NUMBER / OE	PRAVÁ / RIGHT / RECHTS / ПРАВАЯ	LEVÁ / LEFT / LINKS / ЛЕВАЯ	OSVĚTLENÍ SPZ / ILLUMINATION FOR NUMBERPLATE / KENNZEICHENLEUCHE / ПОДСВЕТКА НОМЕРНОГО ЗНАКА	PŘIPOJENÍ / CONNECTION / ANSCHLUSS / СОЕДИНЕНИЕ
721160	2VP340930-021	●			
721161	2VP340930-031		●		
721164 KRYT / LENS / LICHTSCHEIBE / СТЕКЛО ФАРЫ	9EL340829-021	●			
721165 KRYT / LENS / LICHTSCHEIBE / СТЕКЛО ФАРЫ	9EL340829-031		●		

ŽÁROVKA / BULB / GLÜHLAMPE / ЛАМПОЧКА

722932	4x	P21W 24V, BA15s
722944	2x	R10W 24V, BA15s

OPRavná SADA / REPAIR KIT / ANSCHLUSSATZ / РЕМОНТНЫЙ КОМПЛЕКТ

720511	
---------------	--

EASYCONN I.

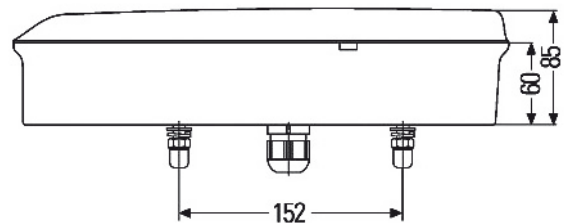
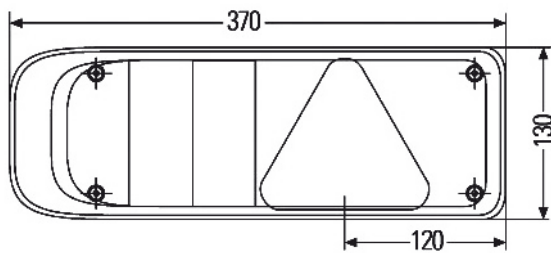
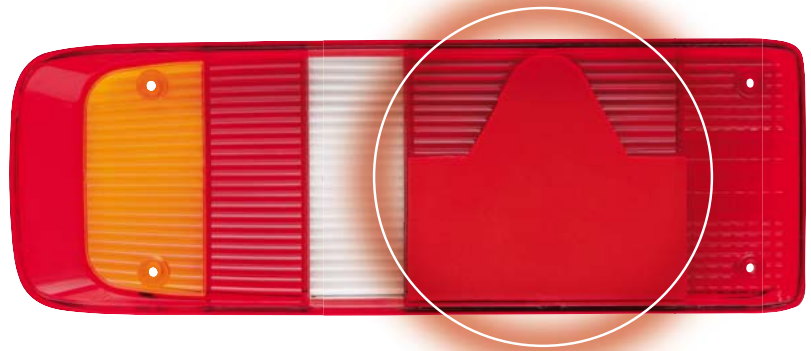

KÓD / ORDER CODE / BESTELL NR. / КОД	OE / OE NUMBER / OE NUMBER / OE	PRAVÁ / RIGHT / RECHTS / ПРАВАЯ	LEVÁ / LEFT / LINKS / ЛЕВАЯ	OSVĚTLENÍ SPZ / ILLUMINATION FOR NUMBERPLATE / KENNZEICHENLEUCHTE / ПОДСВЕТКА НОМЕРНОГО ЗНАКА	PŘIPOJENÍ / CONNECTION / ANSCHLUSS / СОЕДИНЕНИЕ
720514	2VP340830-021	●			
720515	2VP340830-031		●		
720516 KRYT / LENS / LICHTSCHEIBE / СТЕКЛО ФАРЫ	9EL340829-001	●			
720517 KRYT / LENS / LICHTSCHEIBE / СТЕКЛО ФАРЫ	9EL340829-011		●		

ŽÁROVKA / BULB / GLÜHLAMPE / ЛАМПОЧКА

722932	4x	P21W 24V, BA15s
722944	1x	R10W 24V, BA15s

OPRavná SADA / REPAIR KIT / ANSCHLUSSATZ / РЕМОУНТНЫЙ КОМПЛЕКТ

720511		
---------------	--	--

EASYCONN I.

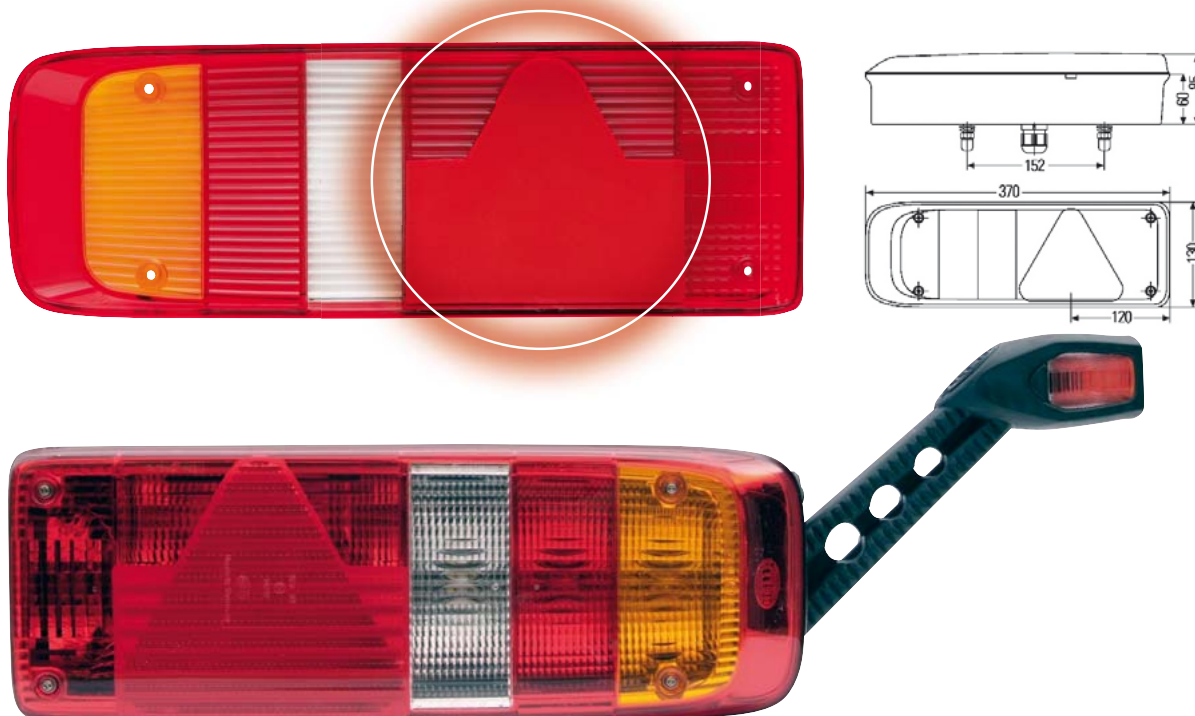

KÓD / ORDER CODE / BESTELL NR. / КОД	OE / OE NUMBER / OE NUMBER / OE	PRAVÁ / RIGHT / RECHTS / ПРАВАЯ	LEVÁ / LEFT / LINKS / ЛЕВАЯ	OSVĚTLENÍ SPZ / ILLUMINATION FOR NUMBERPLATE / KENNZEICHENLEUCHE / ПОДСВЕТКА НОМЕРНОГО ЗНАКА	PŘIPOJENÍ / CONNECTION / ANSCHLUSS / СОЕДИНЕНИЕ
720512	2VP340830-101	●			
720513	2VP340830-111		●		
720516 KRYT / LENS / LICHTSCHEIBE / СТЕКЛО ФАРЫ	9EL340829-001	●			
720517 KRYT / LENS / LICHTSCHEIBE / СТЕКЛО ФАРЫ	9EL340829-011		●		

KÓD / ORDER CODE / BESTELL NR. / КОД	POPIS / DESCRIPTION / BESCHREIBUNG / ОПИСАНИЕ	OE / OE NUMBER / OE NUMBER / OE	NÁKRES / DRAWING / ZEICHNUNG / ЧЕРТЁЖ
720611 PRAVÁ / RIGHT / RECHTS / ПРАВАЯ	<p>ČERVENÁ + BÍLÁ + ORANŽOVÁ, KABEL - 0,5m / RED + WHITE + ORANGE, CABLE - 0,5m / ROT + WEISS + ORANGE, KABEL - 0,5m / КРАСНАЯ + БЕЛАЯ + ОРАНЖЕВАЯ, КАБЕЛЬ - 0,5м</p>	2XS340827-001	
720613 LEVÁ / LEFT / LINKS / ЛЕВАЯ		2XS340827-011	
			722949 24V T4W 24V, BA9s

ŽÁROVKA / BULB / GLÜHLAMPE / ЛАМПОЧКА

722932	4x	P21W 24V, BA15s
722944	1x	R10W 24V, BA15s
722949	1x	T4W 24V, BA9s

OPRÁVNÁ SADA / REPAIR KIT / ANSCHLUSSATZ / РЕМОНТНЫЙ КОМПЛЕКТ

720511	
---------------	--

EASYCONN II.

LED TROJÚHELNÍK / LED TRIANGEL / LED TRIANGEL / СВЕТОДИОДНЫЙ СВЕТООТРАЖАЮЩИЙ ТРЕУГОЛЬНИК

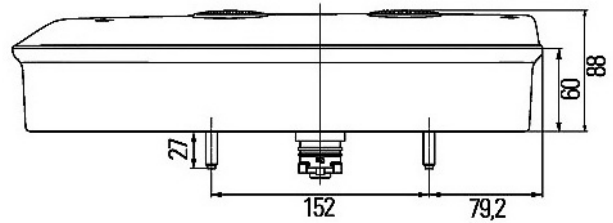
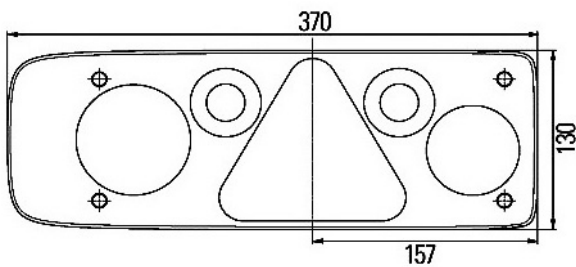

KÓD / ORDER CODE / BESTELL NR. / КОД	OE / OE NUMBER / OE NUMBER / OE	PRAVÁ / RIGHT / RECHTS / ПРАВАЯ	LEVÁ / LEFT / LINKS / ЛЕВАЯ	OSVĚTLENÍ SPZ / ILLUMINATION FOR NUMBERPLATE / KENNZEICHENLEUCHE / ПОДСВЕТКА НОМЕРНОГО ЗНАКА	PŘIPOJENÍ / CONNECTION / ANSCHLUSS / СОЕДИНЕНИЕ
720562	2VP340942-101	●			
720561	2VP340942-111		●		
720603 KRYT / LENS / LICHTSCHEIBE / СТЕКЛО ФАРЫ	9EL340829-061	●			
720602 KRYT / LENS / LICHTSCHEIBE / СТЕКЛО ФАРЫ	9EL340829-051		●		

KÓD / ORDER CODE / BESTELL NR. / КОД	POPIS / DESCRIPTION / BESCHREIBUNG / ОПИСАНИЕ	OE / OE NUMBER / OE NUMBER / OE	NÁKRES / DRAWING / ZEICHNUNG / ЧЕРТЁЖ
720611 PRAVÁ / RIGHT / RECHTS / ПРАВАЯ	ČERVENÁ + BILÁ + ORANŽOVÁ, KABEL - 0,5m / RED + WHITE + ORANGE, CABLE - 0,5m / ROT + WEISS + ORANGE, KABEL - 0,5m / КРАСНАЯ + БЕЛАЯ + ОРАНЖЕВАЯ, КАБЕЛЬ - 0,5м	2XS340827-001	
720613 LEVÁ / LEFT / LINKS / ЛЕВАЯ		2XS340827-011	
			722949 24V T4W 24V, BA9s

ŽÁROVKA / BULB / GLÜHLAMPE / ЛАМПОЧКА

722932	4x	P21W 24V, BA15s
722935	1x	PY21W 24V, BAU15s

OPRavná SADA / REPAIR KIT / ANSCHLUSSATZ / РЕМОНТНЫЙ КОМПЛЕКТ

720511	
---------------	--

EASYCONN NEXTGENERATION

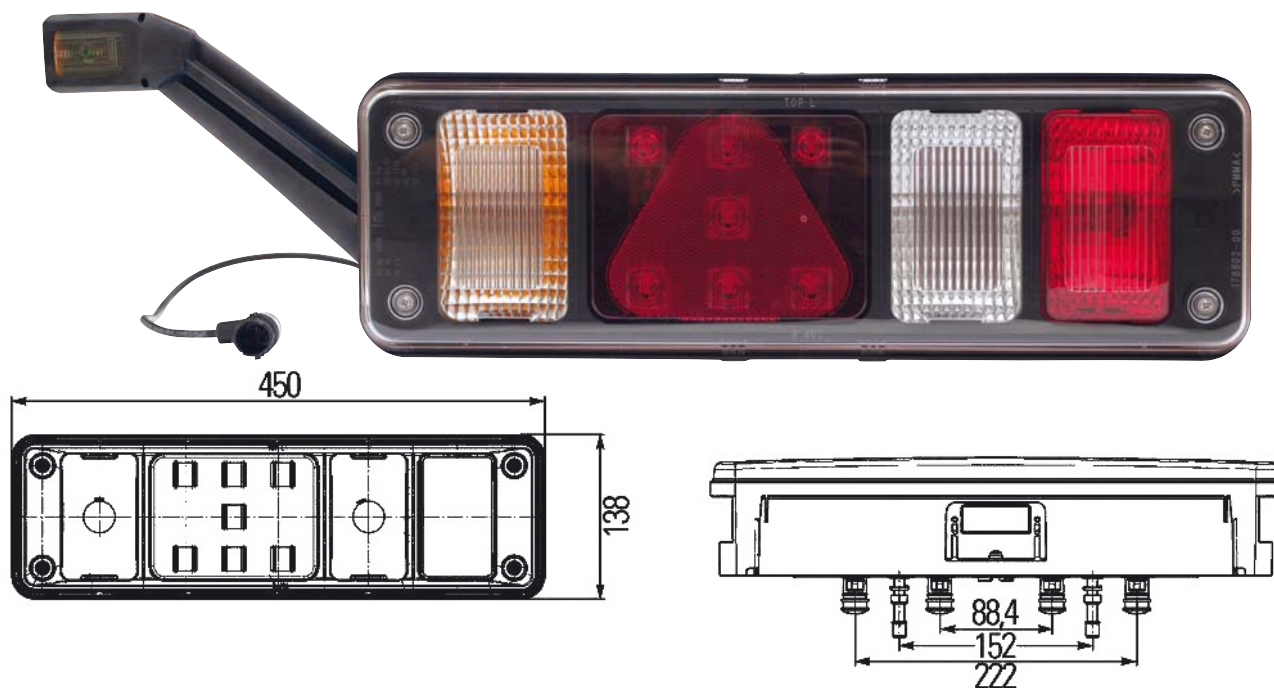

KÓD / ORDER CODE / BESTELL NR. / КОД	OE / OE NUMBER / OE NUMBER / OE	PRAVÁ / RIGHT / RECHTS / ПРАВАЯ	LEVÁ / LEFT / LINKS / ЛЕВАЯ	OSVĚTLENÍ SPZ / ILLUMINATION FOR NUMBERPLATE / KENNZEICHENLEUCHE / ПОДСВЕТКА НОМЕРНОГО ЗНАКА	PŘIPOJENÍ / CONNECTION / ANSCHLUSS / СОЕДИНЕНИЕ
720789	2VP340961-121	●			
720790	2VP340961-111		●		
720791 KRYT / LENS / LICHTSCHEIBE / СТЕКЛО ФАРЫ	9EL183432-001	●	●		

KÓD / ORDER CODE / BESTELL NR. / КОД	POPIS / DESCRIPTION / BESCHREIBUNG / ОПИСАНИЕ	OE / OE NUMBER / OE NUMBER / OE	NÁKRES / DRAWING / ZEICHNUNG / ЧЕРТЁЖ
720785 PRAVÁ / RIGHT / RECHTS / ПРАВАЯ	ČERVENÁ + BÍLÁ + ORANŽOVÁ, KABEL - 0,5m / RED + WHITE + ORANGE, CABLE - 0,5m / ROT + WEISS + ORANGE, KABEL - 0,5m / КРАСНАЯ + БЕЛАЯ + ОРАНЖЕВАЯ, КАБЕЛЬ - 0,5м	2XS011744-021	
720786 LEVÁ / LEFT / LINKS / ЛЕВАЯ		2XS011744-011	
		722949	24V T4W 24V, BA9s

ŽÁROVKA / BULB / GLÜHLAMPE / ЛАМПОЧКА

722932	2x	P21W 24V, BA15s
722935	1x	PY21W 24V, BAU15s

OPRavná SADA / REPAIR KIT / ANSCHLUSSATZ / РЕМОНТНЫЙ КОМПЛЕКТ

720511	
---------------	--

ECOLED

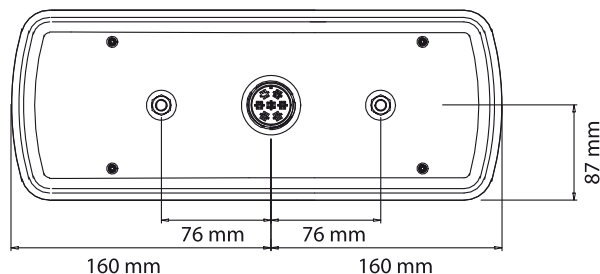
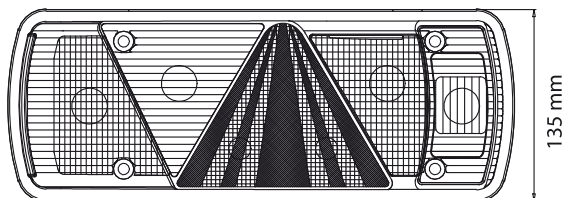

KÓD / ORDER CODE / BESTELL NR. / КОД	OE / OE NUMBER / OE NUMBER / OE	PRAVÁ / RIGHT / RECHTS / ПРАВАЯ	LEVÁ / LEFT / LINKS / ЛЕВАЯ	OSVĚTLENÍ SPZ / ILLUMINATION FOR NUMBERPLATE / KENNZEICHENLEUCHTE / ПОДСВЕТКА НОМЕРНОГО ЗНАКА	PŘIPOJENÍ / CONNECTION / ANSCHLUSS / СОЕДИНЕНИЕ
724855	25-3900-507	●			
724854	25-3800-507		●		

LCG LED MODUL / LCG LED CONTROL - GEAR /
LCG LED KONTROLLE - GANG / LCG СВЕТОДИОДНЫЙ МОДУЛЬ УПРАВЛЕНИЯ

721736	75-0300-007	
--------	-------------	--

OPRAVNÁ SADA / REPAIR KIT /
ANSCHLUSSSATZ / РЕМОУНТНЫЙ КОМПЛЕКТ

725506	13-5626-951	
--------	-------------	--

ECOLED

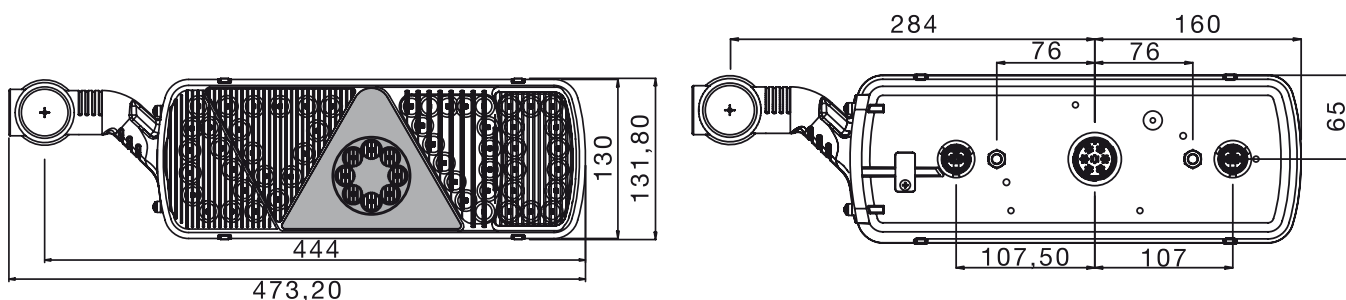

KÓD / ORDER CODE / BESTELL NR. / КОД	OE / OE NUMBER / OE NUMBER / OE	PRAVÁ / RIGHT / RECHTS / ПРАВАЯ	LEVÁ / LEFT / LINKS / ЛЕВАЯ	OSVĚTLENÍ SPZ / ILLUMINATION FOR NUMBERPLATE / KENNZEICHENLEUCHE / ПОДСВЕТКА НОМЕРНОГО ЗНАКА	PŘIPOJENÍ / CONNECTION / ANSCHLUSS / СОЕДИНЕНИЕ
724857	25-3920-517	●			
724856	25-3820-517		●		

KÓD / ORDER CODE / BESTELL NR. / КОД		POPIS / DESCRIPTION / BESCHREIBUNG / ОПИСАНИЕ	OE / OE NUMBER / OE NUMBER / OE	NÁKRES / DRAWING / ZEICHNUNG / ЧЕРТЁЖ
724147 PRAVÁ / RIGHT / RECHTS / ПРАВАЯ		ČERVENÁ + BÍLÁ + ORANŽOVÁ, KABEL - 1,25m / RED + WHITE + ORANGE, CABLE - 1,25m /	31-3306-237	
724148 LEVÁ / LEFT / LINKS / ЛЕВАЯ		ROT + WEISS + ORANGE, KABEL - 1,25m / КРАСНАЯ + БЕЛАЯ + ОРАНЖЕВАЯ, КАБЕЛЬ - 1,25м	31-3305-237	
721468		P & R / P & R CLICK / P & R KLICKEN / P & R	4260089	

LCG LED MODUL / LCG LED CONTROL - GEAR /
LCG LED KONTROLLE - GANG / LCG СВЕТОДИОДНЫЙ МОДУЛЬ УПРАВЛЕНИЯ

721736	75-0300-007	
--------	-------------	--

OPRAVNÁ SADA / REPAIR KIT /
ANSCHLUSSSATZ / РЕМОНТНЫЙ КОМПЛЕКТ

725506	13-5626-951	
--------	-------------	--

ECOLED - KÖGEL

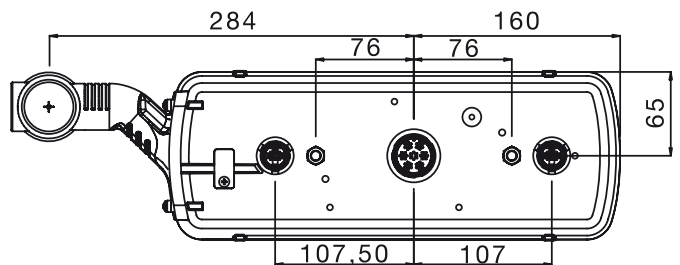
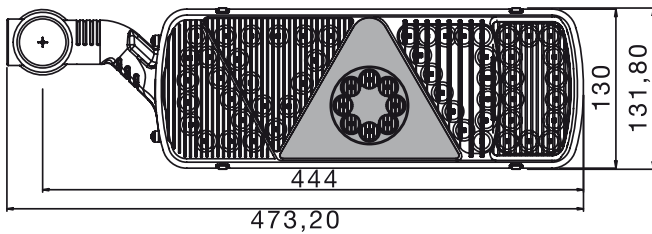

KÓD / ORDER CODE / BESTELL NR. / КОД	OE / OE NUMBER / OE NUMBER / OE	PRAVÁ / RIGHT / RECHTS / ПРАВАЯ	LEVÁ / LEFT / LINKS / ЛЕВАЯ	OSVĚTLENÍ SPZ / ILLUMINATION FOR NUMBERPLATE / KENNZEICHENLEUCHTE / ПОДСВЕТКА НОМЕРНОГО ЗНАКА	PŘIPOJENÍ / CONNECTION / ANSCHLUSS / СОЕДИНЕНИЕ
724861	25-3960-517	•			
724860	25-3860-517		•		

LCG LED MODUL / LCG LED CONTROL - GEAR /
LCG LED KONTROLLE - GANG / LCG СВЕТОДИОДНЫЙ МОДУЛЬ УПРАВЛЕНИЯ

721736	75-0300-007	
--------	-------------	--

OPRAVNÁ SADA / REPAIR KIT /
ANSCHLUSSSATZ / РЕМОНТНЫЙ КОМПЛЕКТ

725506	13-5626-951	
--------	-------------	--

**LED ZADNÍ SVÍTLNÝ / LED REAR LAMPS /
LED HECKLEUCHTEN / ДИОДНЫЕ ЗАДНИЕ ФОНАРИ**

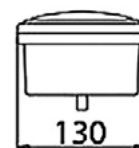
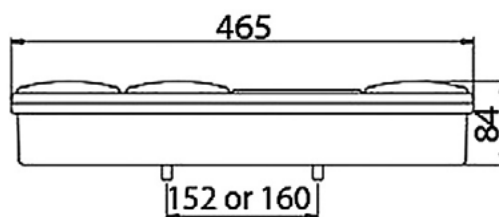
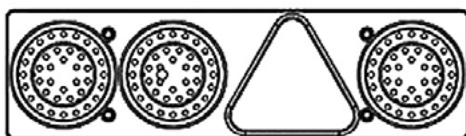

KÓD / ORDER CODE / BESTELL NR. / КОД	OE / OE NUMBER / OE NUMBER / OE	PRAVÁ / RIGHT / RECHTS / ПРАВАЯ	LEVÁ / LEFT / LINKS / ЛЕВАЯ	OSVĚTLENÍ SPZ / ILLUMINATION FOR NUMBERPLATE / KENNZEICHENLEUCHE / ПОДСВЕТКА НОМЕРНОГО ЗНАКА	PŘIPOJENÍ / CONNECTION / ANSCHLUSS / СОЕДИНЕНИЕ
725823		•			
725824			•		

NÁHRADNÍ DÍL / SPARE PART / ERSATZTEIL / ЗАПАСНАЯ ЧАСТЬ

722764	POZIČNÍ SVĚTLO / MARKER LAMP / POSITION LEUCHE / ГАБАРИТНЫЙ ОГОНЬ
--------	--



**LCG LED MODUL / LCG LED CONTROL - GEAR /
LCG LED KONTROLLE - GANG / LCG СВЕТОДИОДНЫЙ МОДУЛЬ УПРАВЛЕНИЯ**

721789	24V	
--------	-----	--

**OPRAVNÁ SADA / REPAIR KIT /
ANSCHLUSSSATZ / РЕМОНТНЫЙ КОМПЛЕКТ**

721493	
--------	--

LED ZADNÍ SVÍTILNY / LED REAR LAMPS /
LED HECKLEUCHTEN / ДИОДНЫЕ ЗАДНИЕ ФОНАРИ

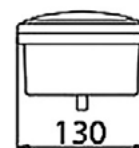
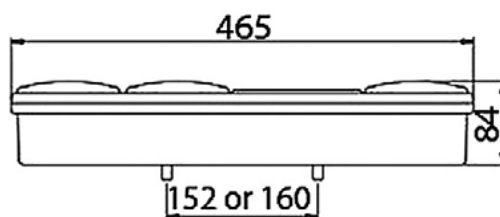
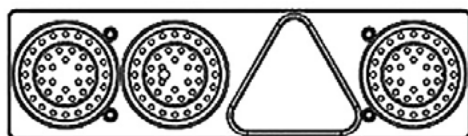

KÓD / ORDER CODE / BESTELL NR. / КОД	OE / OE NUMBER / OE NUMBER / OE	PRAVÁ / RIGHT / RECHTS / ПРАВАЯ	LEVÁ / LEFT / LINKS / ЛЕВАЯ	OSVĚTLENÍ SPZ / ILLUMINATION FOR NUMBERPLATE / KENNZEICHENLEUCHE / ПОДСВЕТКА НОМЕРНОГО ЗНАКА	PŘIPOJENÍ / CONNECTION / ANSCHLUSS / СОЕДИНЕНИЕ
725811		•			
725812			•		

NÁHRADNÍ DÍL / SPARE PART / ERSATZTEIL / ЗАПАСНАЯ ЧАСТЬ

722764	POZIČNÍ SVĚTLO / MARKER LAMP / POSITION LEUCHE / ГАБАРИТНЫЙ ОГОНЬ
--------	--



LCG LED MODUL / LCG LED CONTROL - GEAR /
LCG LED KONTROLLE - GANG / LCG СВЕТОДИОДНЫЙ МОДУЛЬ УПРАВЛЕНИЯ

721789	24V	
--------	-----	--

OPRAVNÁ SADA / REPAIR KIT /
ANSCHLUSSSATZ / РЕМОНТНЫЙ КОМПЛЕКТ

721493		
--------	--	--

**LED ZADNÍ SVÍTLNÝ / LED REAR LAMPS /
LED HECKLEUCHTEN / ДИОДНЫЕ ЗАДНИЕ ФОНАРИ**

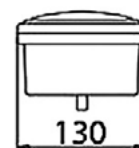
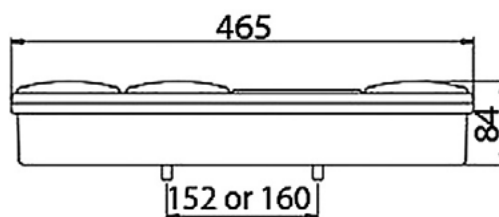
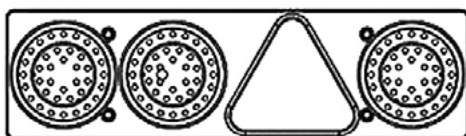

KÓD / ORDER CODE / BESTELL NR. / КОД	OE / OE NUMBER / OE NUMBER / OE	PRAVÁ / RIGHT / RECHTS / ПРАВАЯ	LEVÁ / LEFT / LINKS / ЛЕВАЯ	OSVĚTLENÍ SPZ / ILLUMINATION FOR NUMBERPLATE / KENNZEICHENLEUCHTE / ПОДСВЕТКА НОМЕРНОГО ЗНАКА	PŘIPOJENÍ / CONNECTION / ANSCHLUSS / СОЕДИНЕНИЕ
726554		•			
726555			•		

NÁHRADNÍ DÍL / SPARE PART / ERSATZTEIL / ЗАПАСНАЯ ЧАСТЬ

722764	POZIČNÍ SVĚTLO / MARKER LAMP / POSITION LEUCHTE / ГАБАРИТНЫЙ ОГОНЬ
--------	---



**LCG LED MODUL / LCG LED CONTROL - GEAR /
LCG LED KONTROLLE - GANG / LCG СВЕТОДИОДНЫЙ МОДУЛЬ УПРАВЛЕНИЯ**

721789	24V	
--------	-----	--

**OPRAVNÁ SADA / REPAIR KIT /
ANSCHLUSSSATZ / РЕМОНТНЫЙ КОМПЛЕКТ**

721493	
--------	--

LED ZADNÍ SVÍTILNY / LED REAR LAMPS / LED HECKLEUCHTEN / ДИОДНЫЕ ЗАДНИЕ ФОНАРИ

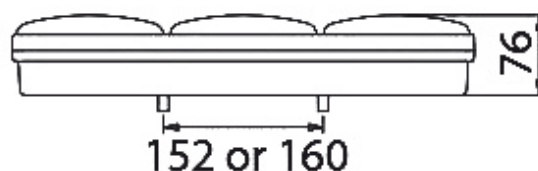
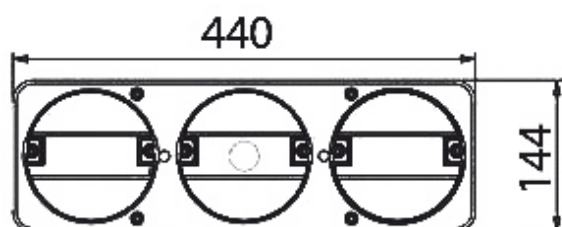

KÓD / ORDER CODE / BESTELL NR. / КОД	OE / OE NUMBER / OE NUMBER / OE	PRAVÁ / RIGHT / RECHTS / ПРАВАЯ	LEVÁ / LEFT / LINKS / ЛЕВАЯ	OSVĚTLENÍ SPZ / ILLUMINATION FOR NUMBERPLATE / KENNZEICHENLEUCHTE / ПОДСВЕТКА НОМЕРНОГО ЗНАКА	PŘIPOJENÍ / CONNECTION / ANSCHLUSS / СОЕДИНЕНИЕ
726556		•			
726557			•		

NÁHRADNÍ DÍL / SPARE PART / ERSATZTEIL / ЗАПАСНАЯ ЧАСТЬ

1	727327	ZADNÍ SVÍTILNA / REAR LAMP / HECKLEUCHTE / ЗАДНИЙ ФОНАРЬ
2	727009	MLHOVKA / REAR FOG LAMP / NEBELSCHLUSSLEUCHTE / ПРОТИВОТУМАННАЯ ФАРА
3	722228	ZPÁTEČKA / REVERSING LAMP / RÜCKFAHRLICHT / ФОНАРЬ ЗАДНЕГО ХОДА
4	722764	POZIČNÍ SVĚTLO / MARKER LAMP / POSITION LEUCHTE / ГАБАРИТНЫЙ ОГОНЬ

LCG LED MODUL / LCG LED CONTROL-GEAR / LCG LED KONTROLLE-GANG / LCG СВЕТОДИОДНЫЙ МОДУЛЬ УПРАВЛЕНИЯ

721789	24V	
--------	-----	--

OPRAVNÁ SADA / REPAIR KIT / ANSCHLUSSSATZ / РЕМОНТНЫЙ КОМПЛЕКТ

721493		
--------	--	--



LED ZADNÍ SVÍTILNY / LED REAR LAMPS / LED HECKLEUCHTEN / ДИОДНЫЕ ЗАДНИЕ ФОНАРИ

LED KONCOVÁ – BRZDOVÁ – SMĚROVKA / LED TAIL – STOP – FLASHER LAMP / LED SCHLUSS – BREMS – BLINKLECHUTE /
СВЕТОДИОДНАЯ ЗАДНЯЯ ФАРА-ЛАМПА СИГНАЛА СТОП/ТОРМАЖЕНИЯ-УКАЗАТЕЛЬ ПОВОРОТА

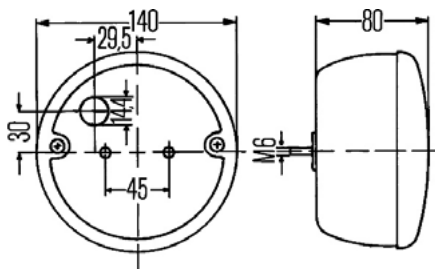

9-33V

KÓD / ORDER CODE / BESTELL NR. / КОД	OE / OE NUMBER / OE NUMMER / OE	PRAVÁ / RIGHT / RECHTS / ПРАВАЯ	LEVÁ / LEFT / LINKS / ЛЕВАЯ	OSVĚTLENÍ SPZ / ILLUMINATION FOR NUMBERPLATE / KENNZEICHENLEUCHTE / ПОДСВЕТКА НОМЕРНОГО ЗНАКА	PŘIPOJENÍ / CONNECTION / ANSCHLUSS / СОЕДИНЕНИЕ
727327		•	•		

LCG LED MODUL / LCG LED CONTROL – GEAR /
LCG LED KONTROLLE – GANG / LCG СВЕТОДИОДНЫЙ МОДУЛЬ УПРАВЛЕНИЯ

721789

24V



LCG LED MODUL / LCG LED CONTROL – GEAR /
LCG LED KONTROLLE – GANG / LCG СВЕТОДИОДНЫЙ МОДУЛЬ УПРАВЛЕНИЯ

721788

12V



LED KONCOVÁ – BRZDOVÁ – SMĚROVKA / LED TAIL – STOP – FLASHER LAMP / LED SCHLUSS – BREMS – BLINKLECHUTE /
СВЕТОДИОДНАЯ ЗАДНЯЯ ФАРА-ЛАМПА СИГНАЛА СТОП/ТОРМАЖЕНИЯ-УКАЗАТЕЛЬ ПОВОРОТА

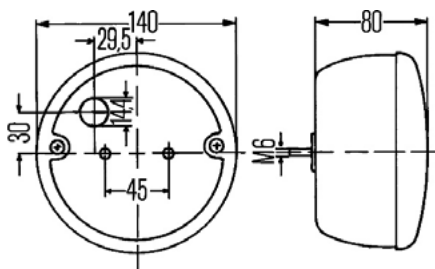

9-33V

KÓD / ORDER CODE / BESTELL NR. / КОД	OE / OE NUMBER / OE NUMMER / OE	PRAVÁ / RIGHT / RECHTS / ПРАВАЯ	LEVÁ / LEFT / LINKS / ЛЕВАЯ	OSVĚTLENÍ SPZ / ILLUMINATION FOR NUMBERPLATE / KENNZEICHENLEUCHTE / ПОДСВЕТКА НОМЕРНОГО ЗНАКА	PŘIPOJENÍ / CONNECTION / ANSCHLUSS / СОЕДИНЕНИЕ
727326		•	•		

LCG LED MODUL / LCG LED CONTROL – GEAR /
LCG LED KONTROLLE – GANG / LCG СВЕТОДИОДНЫЙ МОДУЛЬ УПРАВЛЕНИЯ

721789

24V



LCG LED MODUL / LCG LED CONTROL – GEAR /
LCG LED KONTROLLE – GANG / LCG СВЕТОДИОДНЫЙ МОДУЛЬ УПРАВЛЕНИЯ

721788

12V



LED ZADNÍ SVÍTILNY / LED REAR LAMPS / LED HECKLEUCHTEN / ДИОДНЫЕ ЗАДНИЕ ФОНАРИ

MLHOVKA / REAR FOG LAMP / NEBELSCHLUSSLEUCHTE / ПРОТИВОТУМАННАЯ ФАРА

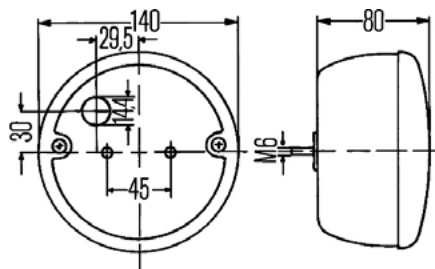

9-33V

KÓD / ORDER CODE / BESTELL NR. / КОД	OE / OE NUMBER / OE NUMMER / OE	PRAVÁ / RIGHT / RECHTS / ПРАВАЯ	LEVÁ / LEFT / LINKS / ЛЕВАЯ	OSVĚTLENÍ SPZ / ILLUMINATION FOR NUMBERPLATE / KENNZEICHENLEUCHTE / ПОДСВЕТКА НОМЕРНОГО ЗНАКА	PŘIPOJENÍ / CONNECTION / ANSCHLUSS / СОЕДИНЕНИЕ
727009		•	•		

LCG LED MODUL / LCG LED CONTROL - GEAR /
LCG LED KONTROLLE - GANG / LCG СВЕТОДИОДНЫЙ МОДУЛЬ УПРАВЛЕНИЯ

721789

24V



LCG LED MODUL / LCG LED CONTROL - GEAR /
LCG LED KONTROLLE - GANG / LCG СВЕТОДИОДНЫЙ МОДУЛЬ УПРАВЛЕНИЯ

721788

12V



ZPÁTEČKA / REVERSING LAMP / RÜCKFAHRLEUCHTE / ФОНАРЬ ЗАДНЕГО ХОДА

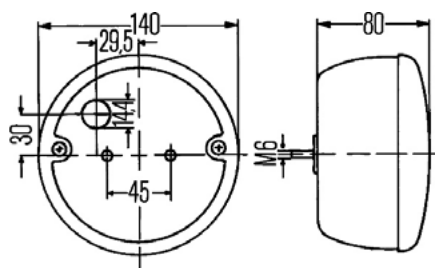

9-33V

KÓD / ORDER CODE / BESTELL NR. / КОД	OE / OE NUMBER / OE NUMMER / OE	PRAVÁ / RIGHT / RECHTS / ПРАВАЯ	LEVÁ / LEFT / LINKS / ЛЕВАЯ	OSVĚTLENÍ SPZ / ILLUMINATION FOR NUMBERPLATE / KENNZEICHENLEUCHTE / ПОДСВЕТКА НОМЕРНОГО ЗНАКА	PŘIPOJENÍ / CONNECTION / ANSCHLUSS / СОЕДИНЕНИЕ
722228		•	•		

LCG LED MODUL / LCG LED CONTROL - GEAR /
LCG LED KONTROLLE - GANG / LCG СВЕТОДИОДНЫЙ МОДУЛЬ УПРАВЛЕНИЯ

721789

24V



LCG LED MODUL / LCG LED CONTROL - GEAR /
LCG LED KONTROLLE - GANG / LCG СВЕТОДИОДНЫЙ МОДУЛЬ УПРАВЛЕНИЯ

721788

12V



LED ZADNÍ SVÍTLNÝ / LED REAR LAMPS / LED HECKLEUCHTEN / ДИОДНЫЕ ЗАДНИЕ ФОНАРИ

LED KONCOVÁ – BRZDOVÁ – SMĚROVKA / LED TAIL – STOP – FLASHER LAMP / LED SCHLUSS – BREMS – BLINKLEUCHTE /
СВЕТОДИОДНАЯ ЗАДНЯЯ ФАРА-ЛАМПА СИГНАЛА СТОП/ТОРМАЖЕНИЯ-УКАЗАТЕЛЬ ПОВОРОТА

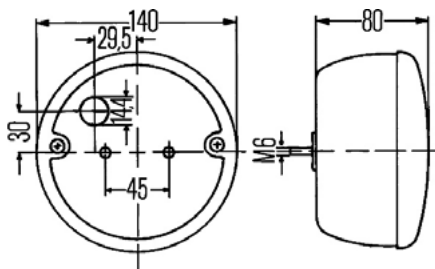

9-33V

KÓD / ORDER CODE / BESTELL NR. / КОД	OE / OE NUMBER / OE NUMMER / OE	PRAVÁ / RIGHT / RECHTS / ПРАВЯЯ	LEVÁ / LEFT / LINKS / ЛЕВАЯ	OSVĚTLENÍ SPZ / ILLUMINATION FOR NUMBERPLATE / KENNZEICHENLEUCHTE / ПОДСВЕТКА НОМЕРНОГО ЗНАКА	PŘIPOJENÍ / CONNECTION / ANSCHLUSS / СОЕДИНЕНИЕ
726735	D13816	•	•		

LCG LED MODUL / LCG LED CONTROL – GEAR /
LCG LED KONTROLLE – GANG / LCG СВЕТОДИОДНЫЙ МОДУЛЬ УПРАВЛЕНИЯ

721789	24V	
--------	-----	--

LCG LED MODUL / LCG LED CONTROL – GEAR /
LCG LED KONTROLLE – GANG / LCG СВЕТОДИОДНЫЙ МОДУЛЬ УПРАВЛЕНИЯ

721788	12V	
--------	-----	--

MLHOVKA / REAR FOG LAMP / NEBELSCHLUSSLEUCHTE / ПРОТИВОТУМАННАЯ ФАРА

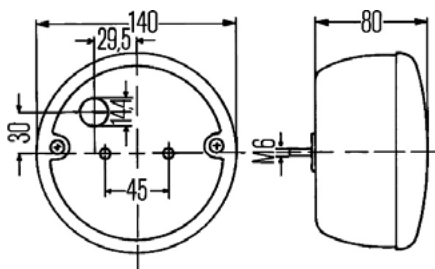

9-33V

KÓD / ORDER CODE / BESTELL NR. / КОД	OE / OE NUMBER / OE NUMMER / OE	PRAVÁ / RIGHT / RECHTS / ПРАВЯЯ	LEVÁ / LEFT / LINKS / ЛЕВАЯ	OSVĚTLENÍ SPZ / ILLUMINATION FOR NUMBERPLATE / KENNZEICHENLEUCHTE / ПОДСВЕТКА НОМЕРНОГО ЗНАКА	PŘIPOJENÍ / CONNECTION / ANSCHLUSS / СОЕДИНЕНИЕ
725980	810/03/00	•	•		

LCG LED MODUL / LCG LED CONTROL – GEAR /
LCG LED KONTROLLE – GANG / LCG СВЕТОДИОДНЫЙ МОДУЛЬ УПРАВЛЕНИЯ

721789	24V	
--------	-----	--

LCG LED MODUL / LCG LED CONTROL – GEAR /
LCG LED KONTROLLE – GANG / LCG СВЕТОДИОДНЫЙ МОДУЛЬ УПРАВЛЕНИЯ

721788	12V	
--------	-----	--

LED ZADNÍ SVÍTLNÝ / LED REAR LAMPS / LED HECKLEUCHTEN / ДИОДНЫЕ ЗАДНИЕ ФОНАРИ

LED KONCOVÁ - BRZDOVÁ - SMĚROVKA / LED TAIL - STOP - FLASHER LAMP / LED SCHLUSS - BREMS - BLINKLECHUTE /
СВЕТОДИОДНАЯ ЗАДНЯЯ ФАРА-ЛАМПА СИГНАЛА СТОП/ТОРМАЖЕНИЯ-УКАЗАТЕЛЬ ПОВОРОТА



9-33V

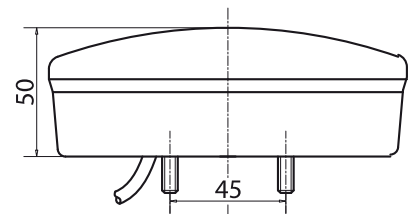
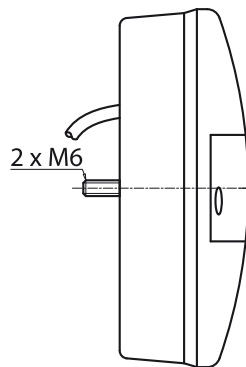
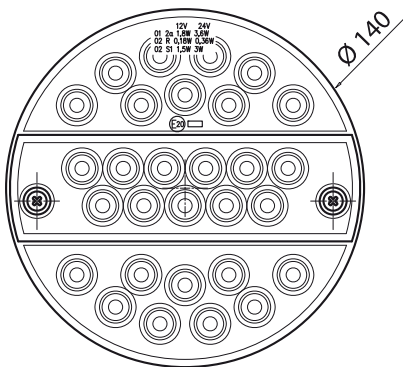

KÓD / ORDER CODE / BESTELL NR. / КОД	OE / OE NUMBER / OE NUMMER / OE	PRAVÁ / RIGHT / RECHTS / ПРАВЯЯ	LEVÁ / LEFT / LINKS / ЛЕВАЯ	OSVĚTLENÍ SPZ / ILLUMINATION FOR NUMBERPLATE / KENNZEICHENLEUCHTE / ПОДСВЕТКА НОМЕРНОГО ЗНАКА	PŘIPOJENÍ / CONNECTION / ANSCHLUSS / СОЕДИНЕНИЕ
726736		•	•		KABEL / CABLE / КАБЕЛЬ / КАБЕЛЬ - 2m

LCG LED MODUL / LCG LED CONTROL - GEAR /
LCG LED KONTROLLE - GANG / LCG СВЕТОДИОДНЫЙ МОДУЛЬ УПРАВЛЕНИЯ

721789

24V



LCG LED MODUL / LCG LED CONTROL - GEAR /
LCG LED KONTROLLE - GANG / LCG СВЕТОДИОДНЫЙ МОДУЛЬ УПРАВЛЕНИЯ

721788

12V



**LED ZADNÍ SVÍTLNÝ / LED REAR LAMPS /
LED HECKLEUCHTEN / ДИОДНЫЕ ЗАДНИЕ ФОНАРИ**

**LED KONCOVÁ - ZPÁTEČKA / LED TAIL - REVERSING LAMP /
LED SCHLUSS - RÜCKFAHRLEUCHTE / СВЕТОДИОДНАЯ ЗАДНЯЯ ФАРА-ФОНАРЬ ЗАДНЕГО ХОДА**



9-33V

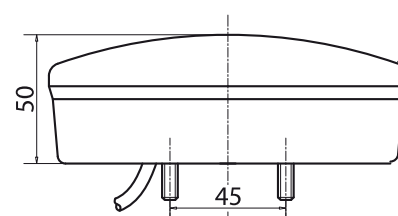
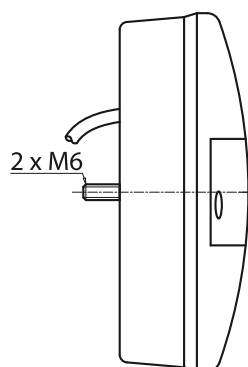
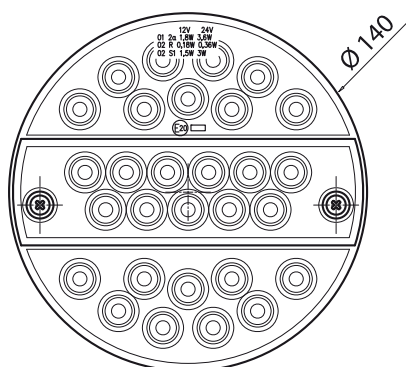

KÓD / ORDER CODE / BESTELL NR. / КОД	OE / OE NUMBER / OE NUMMER / OE	PRAVÁ / RIGHT / RECHTS / ПРАВАЯ	LEVÁ / LEFT / LINKS / ЛЕВАЯ	OSVĚTLENÍ SPZ / ILLUMINATION FOR NUMBERPLATE / KENNZEICHENLEUCHTE / ПОДСВЕТКА НОМЕРНОГО ЗНАКА	PŘIPOJENÍ / CONNECTION / ANSCHLUSS / СОЕДИНЕНИЕ
726737		•	•		KABEL / CABLE / КАБЕЛЬ / КАБЕЛЬ - 2m

**LCG LED MODUL / LCG LED CONTROL - GEAR /
LCG LED KONTROLLE - GANG / LCG СВЕТОДИОДНЫЙ МОДУЛЬ УПРАВЛЕНИЯ**

721789	24V	
---------------	-----	--

**LCG LED MODUL / LCG LED CONTROL - GEAR /
LCG LED KONTROLLE - GANG / LCG СВЕТОДИОДНЫЙ МОДУЛЬ УПРАВЛЕНИЯ**

721788	12V	
---------------	-----	--

LED ZADNÍ SVÍTLNÝ / LED REAR LAMPS / LED HECKLEUCHTEN / ДИОДНЫЕ ЗАДНИЕ ФОНАРИ

LED KONCOVÁ – BRZDOVÁ – SMĚROVKA / LED TAIL – STOP – FLASHER LAMP / LED SCHLUSS – BREMS – BLINKLECHUTE /
СВЕТОДИОДНАЯ ЗАДНЯЯ ФАРА-ЛАМПА СИГНАЛА СТОП/ТОРМАЖЕНИЯ-УКАЗАТЕЛЬ ПОВОРОТА

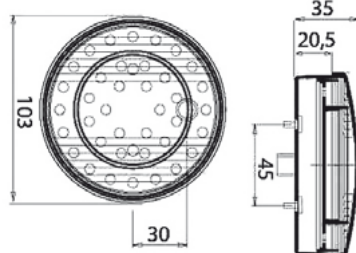

KÓD / ORDER CODE / BESTELL NR. / КОД	OE / OE NUMBER / OE NUMMER / OE	PRAVÁ / RIGHT / RECHTS / ПРАВАЯ	LEVÁ / LEFT / LINKS / ЛЕВАЯ	12V	24V	PŘIPOJENÍ / CONNECTION / ANSCHLUSS / СОЕДИНЕНИЕ
722115		●	●	●		KABEL / CABLE / KABEL / КАБЕЛЬ - 0,9m
722124		●	●		●	

LCG LED MODUL / LCG LED CONTROL – GEAR /
LCG LED KONTROLLE – GANG / LCG СВЕТОДИОДНЫЙ МОДУЛЬ УПРАВЛЕНИЯ

721789

24V



LCG LED MODUL / LCG LED CONTROL – GEAR /
LCG LED KONTROLLE – GANG / LCG СВЕТОДИОДНЫЙ МОДУЛЬ УПРАВЛЕНИЯ

721788

12V



LED KONCOVÁ – BRZDOVÁ – SMĚROVKA / LED TAIL – STOP – FLASHER LAMP / LED SCHLUSS – BREMS – BLINKLECHUTE /
СВЕТОДИОДНАЯ ЗАДНЯЯ ФАРА-ЛАМПА СИГНАЛА СТОП/ТОРМАЖЕНИЯ-УКАЗАТЕЛЬ ПОВОРОТА

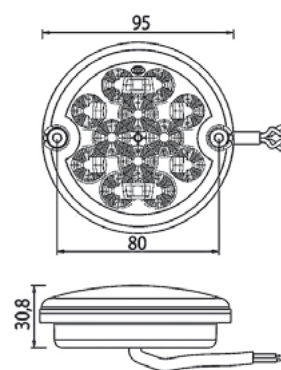
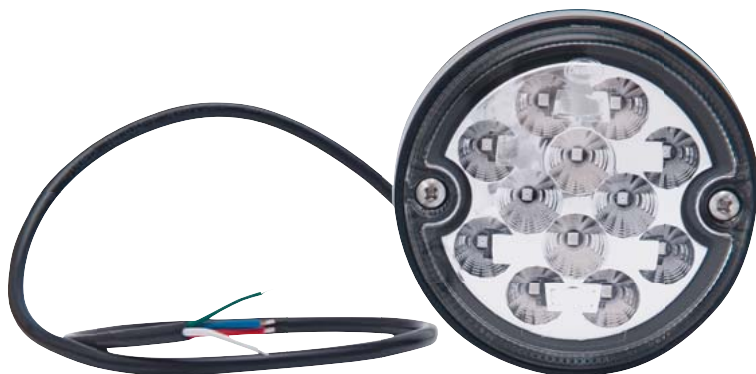

9-33V

KÓD / ORDER CODE / BESTELL NR. / КОД	OE / OE NUMBER / OE NUMMER / OE	PRAVÁ / RIGHT / RECHTS / ПРАВАЯ	LEVÁ / LEFT / LINKS / ЛЕВАЯ	12V	24V	PŘIPOJENÍ / CONNECTION / ANSCHLUSS / СОЕДИНЕНИЕ
722116		●	●	●	●	KABEL / CABLE / KABEL / КАБЕЛЬ - 0,9m

LCG LED MODUL / LCG LED CONTROL – GEAR /
LCG LED KONTROLLE – GANG / LCG СВЕТОДИОДНЫЙ МОДУЛЬ УПРАВЛЕНИЯ

721789

24V



LCG LED MODUL / LCG LED CONTROL – GEAR /
LCG LED KONTROLLE – GANG / LCG СВЕТОДИОДНЫЙ МОДУЛЬ УПРАВЛЕНИЯ

721788

12V



LED ZADNÍ SVÍTLNÝ / LED REAR LAMPS / LED HECKLEUCHTEN / ДИОДНЫЕ ЗАДНИЕ ФОНАРИ

ZPÁTEČKA / REVERSING LAMP / RÜCKFAHRLEUCHE / ФОНАРЬ ЗАДНЕГО ХОДА

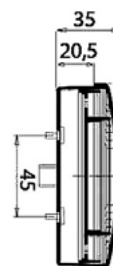
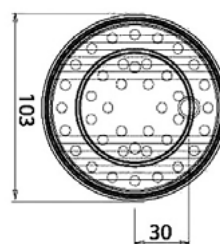

KÓD / ORDER CODE / BESTELL NR. / КОД	OE / OE NUMBER / OE NUMBER / OE	PRAVÁ / RIGHT / RECHTS / ПРАВАЯ	LEVÁ / LEFT / LINKS / ЛЕВАЯ	12V	24V	PŘIPOJENÍ / CONNECTION / ANSCHLUSS / СОЕДИНЕНИЕ
722549		●	●		●	KABEL / CABLE / KABEL / КАБЕЛЬ - 0,9m

LCG LED MODUL / LCG LED CONTROL - GEAR / LCG LED KONTROLLE - GANG / LCG СВЕТОДИОДНЫЙ МОДУЛЬ УПРАВЛЕНИЯ

721789	24V		
--------	-----	--	--

KONCOVÁ - MLHOVÁ / TAIL - FOG / SCHLUSS - NEBELSCHLUSSLECHTE / ЗАДНЯЯ-ПРОТИВОТУМАННАЯ

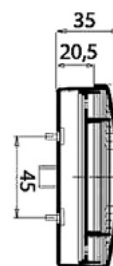
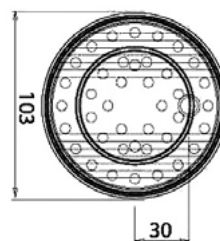

KÓD / ORDER CODE / BESTELL NR. / КОД	OE / OE NUMBER / OE NUMBER / OE	PRAVÁ / RIGHT / RECHTS / ПРАВАЯ	LEVÁ / LEFT / LINKS / ЛЕВАЯ	12V	24V	PŘIPOJENÍ / CONNECTION / ANSCHLUSS / СОЕДИНЕНИЕ
722121		●	●		●	KABEL / CABLE / KABEL / КАБЕЛЬ - 0,9m

LCG LED MODUL / LCG LED CONTROL - GEAR / LCG LED KONTROLLE - GANG / LCG СВЕТОДИОДНЫЙ МОДУЛЬ УПРАВЛЕНИЯ

721789	24V		
--------	-----	--	--

LED ZADNÍ SVÍTLNÝ / LED REAR LAMPS / LED HECKLEUCHTEN / ДИОДНЫЕ ЗАДНИЕ ФОНАРИ



KÓD / ORDER CODE / BESTELL NR. / КОД		PRAVÁ / RIGHT / RECHTS / ПРАВЯ	LEVÁ / LEFT / LINKS / ЛЕВАЯ	12V	24V	PŘIPOJENÍ / CONNECTION / ANSCHLUSS / СОЕДИНЕНИЕ
721777 SMĚROVKA / FRONT INDICATOR / BLINKLEUCHE / УКАЗАТЕЛЬ ПОВОРОТА		•	•	•		KABEL / CABLE / KABEL / КАБЕЛЬ - 0,2m
721778 SMĚROVKA / FRONT INDICATOR / BLINKLEUCHE / УКАЗАТЕЛЬ ПОВОРОТА		•	•		•	KABEL / CABLE / KABEL / КАБЕЛЬ - 0,2m
721769 KONCOVÁ - BRZDOVÁ / TAIL - STOP / SCHLUSS - BREMS / ЗАДНЯЯ ФАРА-ЛАМПА СИГНАЛА СТОП/ТОРМОЖЕНИЯ		•	•	•	•	KABEL / CABLE / KABEL / КАБЕЛЬ - 0,2m
721774 MLHŮVKA / REAR FOG LAMP / NEBELSCHLUSSLEUCHE / ПРОТИВОТУМАННАЯ ЛАМПА		•	•	•	•	KABEL / CABLE / KABEL / КАБЕЛЬ - 0,2m
721776 ZPĚTĚČKA / REVERSING LAMP / RÜCKFAHRLAUCHE / ФОНАРЬ ЗАДНЕГО ХОДА		•	•	•	•	KABEL / CABLE / KABEL / КАБЕЛЬ - 0,2m
721779 SMĚROVKA / FRONT INDICATOR / BLINKLEUCHE / УКАЗАТЕЛЬ ПОВОРОТА		•	•	•		KABEL / CABLE / KABEL / КАБЕЛЬ - 0,2m
721780 SMĚROVKA / FRONT INDICATOR / BLINKLEUCHE / УКАЗАТЕЛЬ ПОВОРОТА		•	•		•	KABEL / CABLE / KABEL / КАБЕЛЬ - 0,2m
721770 KONCOVÁ - BRZDOVÁ / TAIL - STOP / SCHLUSS - BREMS / ЗАДНЯЯ ФАРА-ЛАМПА СИГНАЛА СТОП/ТОРМОЖЕНИЯ		•	•	•		KABEL / CABLE / KABEL / КАБЕЛЬ - 0,2m
721771 KONCOVÁ - BRZDOVÁ / TAIL - STOP / SCHLUSS - BREMS / ЗАДНЯЯ ФАРА-ЛАМПА СИГНАЛА СТОП/ТОРМОЖЕНИЯ		•	•		•	KABEL / CABLE / KABEL / КАБЕЛЬ - 0,2m
721781 ODRAZKA / REFLEX REFLECTOR / RÜCKSTRAHLER / СВЕТООТРАЖАТЕЛЬ		•	•			

LCG LED MODUL / LCG LED CONTROL - GEAR /
LCG LED KONTROLLE - GANG / LCG СВЕТОДИОДНЫЙ МОДУЛЬ УПРАВЛЕНИЯ

721789	24V	
---------------	-----	--

LCG LED MODUL / LCG LED CONTROL - GEAR /
LCG LED KONTROLLE - GANG / LCG СВЕТОДИОДНЫЙ МОДУЛЬ УПРАВЛЕНИЯ

721788	12V	
---------------	-----	--

ZADNÍ SVÍTILNY / REAR LAMPS /
HECKLEUCHTEN / ЗАДНИЕ ФОНАРИ

3 KOMOROVÉ SVĚTLO / 3-CHAMBER LIGHT / 3-KAMMER LEUCHTE / 3-ФУНКЦИОНАЛЬНАЯ ФАРА

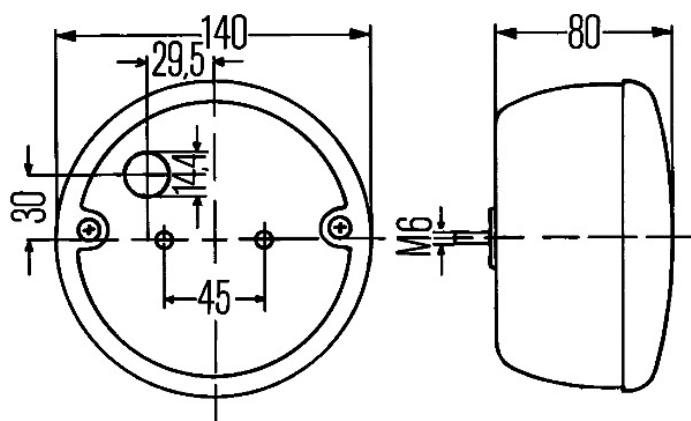

KÓD / ORDER CODE / BESTELL NR. / КОД	OE / OE NUMBER / OE NUMMER / OE	PRAVÁ / RIGHT / RECHTS / ПРАВАЯ	LEVÁ / LEFT / LINKS / ЛЕВАЯ	OSVĚTLENÍ SPZ / ILLUMINATION FOR NUMBERPLATE / KENNZEICHENLEUCHTE / ПОДСВЕТКА НОМЕРНОГО ЗНАКА	PŘIPOJENÍ / CONNECTION / ANSCHLUSS / СОЕДИНЕНИЕ
727335		•			
727336			•	•	
727337 KRYT / LENS / LICHTSCHEIBE / СТЕКЛО ФАРЫ		•	•		

ŽÁROVKA / BULB / GLÜHLAMPE / ЛАМПОЧКА

12V	722931	2x	P21W 12V, BA15s	24V	722932	2x	P21W 24V, BA15s
12V	722940	1x	R5W 12V, BA15s	24V	722941	1x	R5W 24V, BA15s

3 KOMOROVÉ SVĚTLO / 3-CHAMBER LIGHT / 3-KAMMER LEUCHTE / 3-ФУНКЦИОНАЛЬНАЯ ФАРА

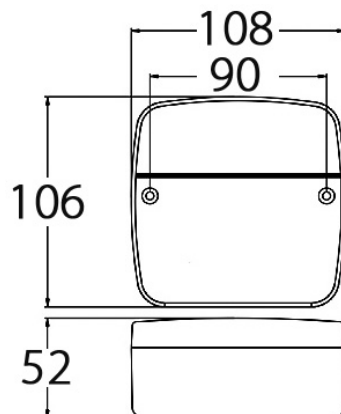

KÓD / ORDER CODE / BESTELL NR. / КОД	OE / OE NUMBER / OE NUMBER / OE	PRAVÁ / RIGHT / RECHTS / ПРАВАЯ	LEVÁ / LEFT / LINKS / ЛЕВАЯ	OSVĚTLENÍ SPZ / ILLUMINATION FOR NUMBERPLATE / KENNZEICHENLEUCHTE / ПОДСВЕТКА НОМЕРНОГО ЗНАКА	PŘIPOJENÍ / CONNECTION / ANSCHLUSS / СОЕДИНЕНИЕ
720017		•	•	•	

ŽÁROVKA / BULB / GLÜHLAMPE / ЛАМПОЧКА

12V	722931	2x	P21W 12V, BA15s	24V	722932	2x	P21W 24V, BA15s
12V	722940	1x	R5W 12V, BA15s	24V	722941	1x	R5W 24V, BA15s

**ZADNÍ SVÍTLNÝ / REAR LAMPS /
HECKLEUCHTEN / ЗАДНИЕ ФОНАРИ**

**2 KOMOROVÉ KONCOVÉ - BRZDOVÉ - SMĚROVKA / 2-CHAMBER LIGHT TAIL - STOP - FLASHER LAMP /
2-KAMMER LEUCHTE SCHLUSS - BREMS - BLINKLEUCHTE /
2-ФУНКЦИОНАЛЬНАЯ ЗАДНЯЯ ФАРА-ЛАМПА СИГНАЛА СТОП/ТОРМАЖЕНИЯ-УКАЗАТЕЛЬ ПОВОРОТА**

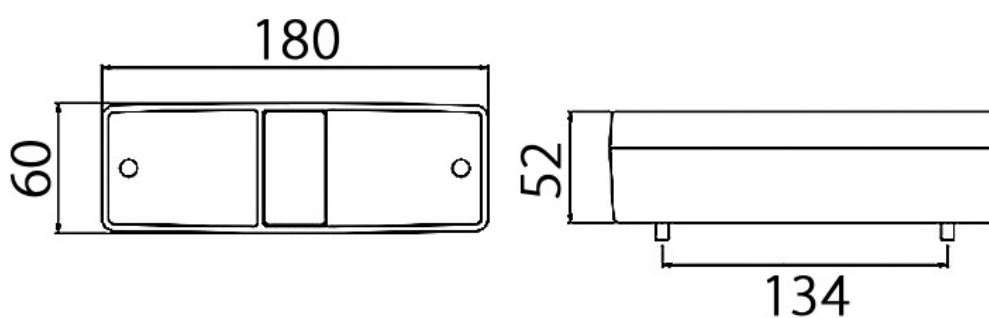

KÓD / ORDER CODE / BESTELL NR. / КОД	OE / OE NUMBER / OE NUMMER / OE	PRAVÁ / RIGHT / RECHTS / ПРАВАЯ	LEVÁ / LEFT / LINKS / ЛЕВАЯ	OSVĚTLENÍ SPZ / ILLUMINATION FOR NUMBERPLATE / KENNZEICHENLEUCHTE / ПОДСВЕТКА НОМЕРНОГО ЗНАКА	PŘIPOJENÍ / CONNECTION / ANSCHLUSS / СОЕДИНЕНИЕ
722221		•	•		

ŽÁROVKA / BULB / GLÜHLAMPE / ЛАМПОЧКА

12V	722937	1x	P21 5W 12V, BAY15d	24V	722938	1x	P21 5W 24V, BAY15d
12V	722931	1x	P21W 12V, BA15s	24V	722932	1x	P21W 24V, BA15s

3 KOMOROVÉ SVĚTLO / 3-CHAMBER LIGHT / 3-KAMMER LEUCHTE / 3-ФУНКЦИОНАЛЬНАЯ ФАРА

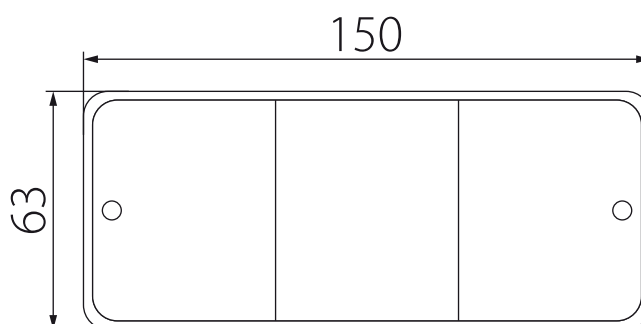

KÓD / ORDER CODE / BESTELL NR. / КОД	OE / OE NUMBER / OE NUMMER / OE	PRAVÁ / RIGHT / RECHTS / ПРАВАЯ	LEVÁ / LEFT / LINKS / ЛЕВАЯ	OSVĚTLENÍ SPZ / ILLUMINATION FOR NUMBERPLATE / KENNZEICHENLEUCHTE / ПОДСВЕТКА НОМЕРНОГО ЗНАКА	PŘIPOJENÍ / CONNECTION / ANSCHLUSS / СОЕДИНЕНИЕ
720120		•			
720121			•		
720100 KRYT / LENS / LICHTSCHEIBE / СТЕКЛО ФАРЫ		•	•		

ŽÁROVKA / BULB / GLÜHLAMPE / ЛАМПОЧКА

12V	722931	2x	P21W 12V, BA15s	24V	722932	2x	P21W 24V, BA15s
12V	722940	1x	R5W 12V, BA15s	24V	722941	1x	R5W 24V, BA15s

MIDIPOINT I.

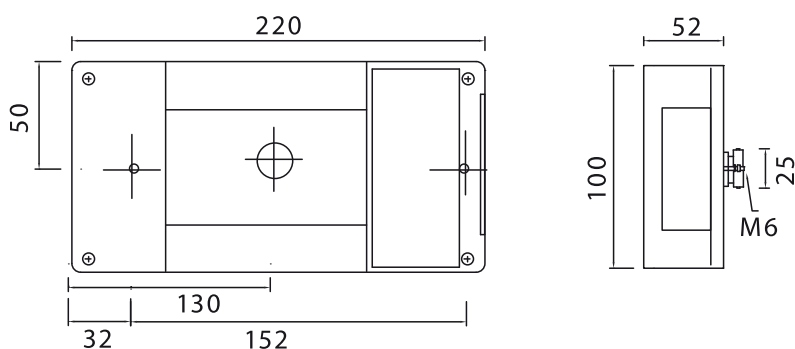

KÓD / ORDER CODE / BESTELL NR. / КОД	OE / OE NUMBER / OE NUMBER / OE	PRAVÁ / RIGHT / RECHTS / ПРАВАЯ	LEVÁ / LEFT / LINKS / ЛЕВАЯ	OSVĚTLENÍ SPZ / ILLUMINATION FOR NUMBERPLATE / KENNZEICHENLEUCHTE / ПОДСВЕТКА НОМЕРНОГО ЗНАКА	ZPÁTEČKA / REVERSING LAMP / RÜCKFAHRLEUCHTE / ФОНАРЬ ЗАДНЕГО ХОДА	MLHOVKA / REAR FOG LAMP / NEBEL / ПРОТИВОТУМАННАЯ ФАРА
721194	24-6000-007	●	●	●		●
721195	24-6210-007	●	●	●	●	
721196	24-6002-507	●	●	●		●
721198 KRYT / LENS / LICHTSCHEIBE / СТЕКЛО ФАРЫ	18-8460-007	●	●	●		●
721197 KRYT / LENS / LICHTSCHEIBE / СТЕКЛО ФАРЫ	18-8462-107	●	●	●	●	

ŽÁROVKA / BULB /
GLÜHLAMPE / ЛАМПОЧКА

12V	722931	2x	P21W 12V, BA15s
12V	722937	1x	P21 5W 12V, BAY15d
12V	722950	1x	C5W 12V, SV8,5-8
24V	722932	2x	P21W 24V, BA15s
24V	722938	1x	P21 5W 24V, BAY15d
24V	722951	1x	C5W 24V, SV8,5-8

OPRavná SADA / REPAIR KIT /
ANSCHLUSSSATZ / РЕМОНТНЫЙ КОМПЛЕКТ

721761 PRAVÁ / RIGHT / RECHTS / ПРАВАЯ	13-0523-044	
721760 LEVÁ / LEFT / LINKS / ЛЕВАЯ	13-0521-044	

PŘIPOJENÍ / CONNECTION /
ANSCHLUSS / СОЕДИНЕНИЕ



MIDIPOINT II.

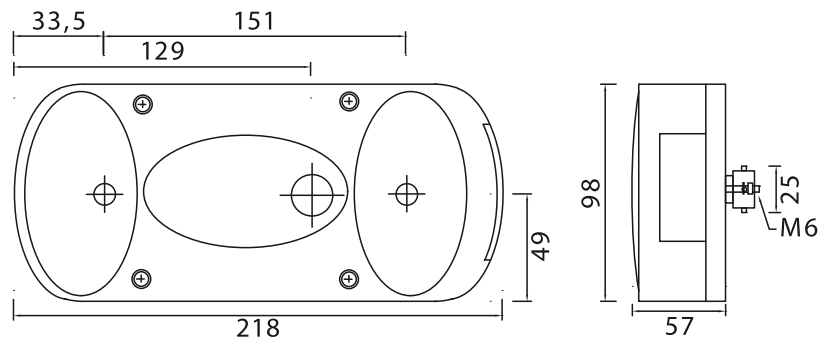

KÓD / ORDER CODE / BESTELL NR. / КОД	OE / OE NUMBER / OE NUMBER / OE	PRAVÁ / RIGHT / RECHTS / ПРАВЯЯ	LEVÁ / LEFT / LINKS / ЛЕВАЯ	OSVĚTLENÍ SPZ / ILLUMINATION FOR NUMBERPLATE / KENNZEICHENLEUCHE / ПОДСВЕТКА НОМЕРНОГО ЗНАКА	ZPÁTEČKA / REVERSING LAMP / RÜCKFAHRLEUCHE / ФОНАРЬ ЗАДНЕГО ХОДА	MLHOVKA / REAR FOG LAMP / NEBEL / ПРОТИВТУМАННАЯ ФАРА
725560	24-3000-007	●	●	●		●
725561	24-3200-007	●	●	●		
725562	24-3210-007	●	●	●	●	
725563 KRYT / LENS / LICHTSCHEIBE / СТЕКЛО ФАРЫ	18-8430-007	●	●	●		
725564 KRYT / LENS / LICHTSCHEIBE / СТЕКЛО ФАРЫ	18-8432-107	●	●	●	●	●

ZÁROVKA / BULB /
GLÜHLAMPE / ЛАМПОЧКА

12V	722931	2x	P21W 12V, BA15s
12V	722937	1x	P21 5W 12V, BAY15d
12V	722950	1x	C5W 12V, SV8,5-8
24V	722932	2x	P21W 24V, BA15s
24V	722938	1x	P21 5W 24V, BAY15d
24V	722951	1x	C5W 24V, SV8,5-8

OPRavná SADA / REPAIR KIT /
ANSCHLUSSSATZ / РЕМОНТНЫЙ КОМПЛЕКТ

721761 PRAVÁ / RIGHT / RECHTS / ПРАВЯЯ	13-0523-044	
721760 LEVÁ / LEFT / LINKS / ЛЕВАЯ	13-0521-044	

PŘIPOJENÍ / CONNECTION /
ANSCHLUSS / СОЕДИНЕНИЕ



MULTIPOINT I.

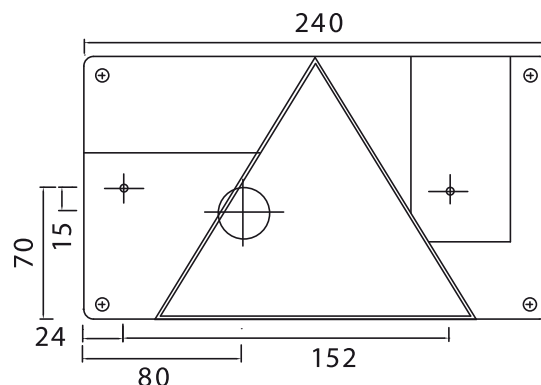

KÓD / ORDER CODE / BESTELL NR. / КОД	OE / OE NUMBER / OE NUMMER / OE	PRAVÁ / RIGHT / RECHTS / ПРАВАЯ	LEVÁ / LEFT / LINKS / ЛЕВАЯ	OSVĚTLENÍ SPZ / ILLUMINATION FOR NUMBERPLATE / KENNZEICHENLEUCHE / ПОДСВЕТКА НОМЕРНОГО ЗНАКА	ZPÁTEČKA / REVERSING LAMP / RÜCKFAHRLEUCHE / ФОНАРЬ ЗАДНЕГО ХОДА	MLHOVKA / REAR FOG LAMP / NEBEL / ПРОТИВОТУМАННАЯ ФАРА
721756	24-5210-007	●		●	●	
721758	24-5200-007	●		●		
721754	24-5000-007		●	●		●
721759 KRYT / LENS / LICHTSCHEIBE / СТЕКЛО ФАРЫ	18-8452-007	●		●		
721757 KRYT / LENS / LICHTSCHEIBE / СТЕКЛО ФАРЫ	18-8452-107	●		●	●	
721755 KRYT / LENS / LICHTSCHEIBE / СТЕКЛО ФАРЫ	18-8450-007		●	●		●

ŽÁROVKA / BULB /
GLÜHLAMPE / ЛАМПОЧКА

12V	722931	2x	P21W 12V, BA15s
12V	722937	1x	P21 5W 12V, BAY15d
12V	722950	1x	C5W 12V, SV8,5-8
24V	722932	2x	P21W 24V, BA15s
24V	722938	1x	P21 5W 24V, BAY15d
24V	722951	1x	C5W 24V, SV8,5-8

OPRavná SADA / REPAIR KIT /
ANSCHLUSSSATZ / РЕМОНТНЫЙ КОМПЛЕКТ

721761 PRAVÁ / RIGHT / RECHTS / ПРАВАЯ	13-0523-044	
721760 LEVÁ / LEFT / LINKS / ЛЕВАЯ	13-0521-044	

PŘIPOJENÍ / CONNECTION /
ANSCHLUSS / СОЕДИНЕНИЕ



MULTIPOINT II.

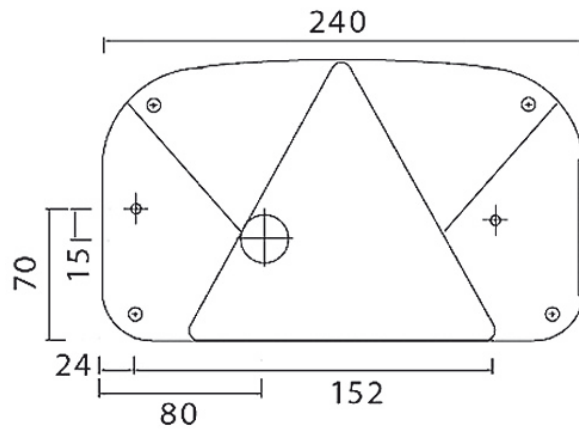

KÓD / ORDER CODE / BESTELL NR. / КОД	OE / OE NUMBER / OE NUMBER / OE	PRAVÁ / RIGHT / RECHTS / ПРАВАЯ	LEVÁ / LEFT / LINKS / ЛЕВАЯ	OSVĚTLENÍ SPZ / ILLUMINATION FOR NUMBERPLATE / KENNZEICHENLEUCHE / ПОДСВЕТКА НОМЕРНОГО ЗНАКА	ZPÁTEČKA / REVERSING LAMP / RÜCKFAHRLEUCHE / ФОНАРЬ ЗАДНЕГО ХОДА	MLHOVKA / REAR FOG LAMP / NEBEL / ПРОТИВОТУМАННАЯ ФАРА
722010	24-7200-007	●		●		
722007	24-7210-007	●		●	●	
722011	24-7000-007		●	●		●
722009 KRYT / LENS / LICHTSCHEIBE / СТЕКЛО ФАРЫ	18-8470-007	●	●			

ŽÁROVKA / BULB /
GLÜHLAMPE / ЛАМПОЧКА

12V	722931	1x	P21W 12V, BA15s
12V	722937	1x	P21 5W 12V, BAY15d
12V	722934	1x	PY21W 12V, BAU15s
24V	722932	2x	P21W 24V, BA15s
24V	722938	1x	P21 5W 24V, BAY15d
24V	722935	1x	PY21W 24V, BAU15s

OPRavná SADA / REPAIR KIT /
ANSCHLUSSSATZ / РЕМОНТНЫЙ КОМПЛЕКТ

721761 PRAVÁ / RIGHT / RECHTS / ПРАВАЯ	13-0523-044	
721760 LEVÁ / LEFT / LINKS / ЛЕВАЯ	13-0521-044	

PŘIPOJENÍ / CONNECTION /
ANSCHLUSS / СОЕДИНЕНИЕ



MULTIPOINT III.

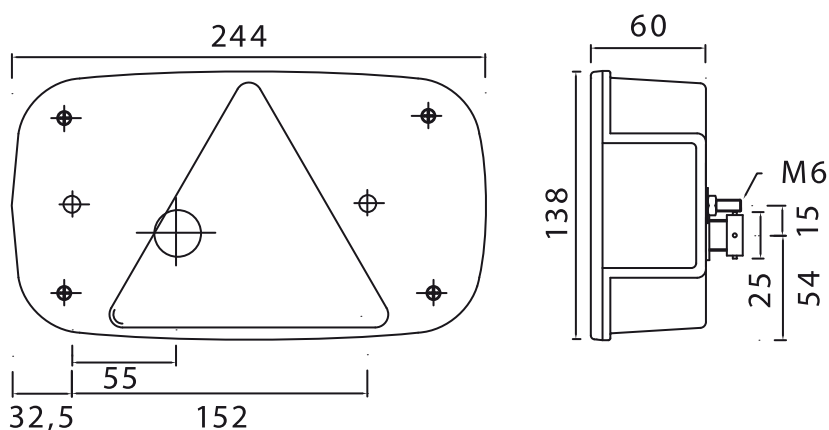

KÓD / ORDER CODE / BESTELL NR. / КОД	OE / OE NUMBER / OE NUMBER / OE	PRAVÁ / RIGHT / RECHTS / ПРАВАЯ	LEVÁ / LEFT / LINKS / ЛЕВАЯ	OSVĚTLENÍ SPZ / ILLUMINATION FOR NUMBERPLATE / KENNZEICHENLEUCHE / ПОДСВЕТКА НОМЕРНОГО ЗНАКА	ZPÁTEČKA / REVERSING LAMP / RÜCKFAHRLEUCHE / ФОНАРЬ ЗАДНЕГО ХОДА	MLHOVKA / REAR FOG LAMP / NEBEL / ПРОТИВОТУМАННАЯ ФАРА
722014	24-8210-007	●		●	●	
722015	24-8000-007		●	●		●
722016 KRYT / LENS / LICHTSCHEIBE / СТЕКЛО ФАРЫ	18-8480-007	●	●			

ŽÁROVKA / BULB /
GLÜHLAMPE / ЛАМПОЧКА

VOLTAGE	CODE	QUANTITY	TYPE
12V	722931	2x	P21W 12V, BA15s
12V	722937	1x	P21 5W 12V, BAY15d
12V	722950	1x	C5W 12V, SV8,5-8
24V	722932	2x	P21W 24V, BA15s
24V	722938	1x	P21 5W 24V, BAY15d
24V	722951	1x	C5W 24V, SV8,5-8

OPRAVNÁ SADA / REPAIR KIT /
ANSCHLUSSSATZ / РЕМОНТНЫЙ КОМПЛЕКТ

721761 PRAVÁ / RIGHT / RECHTS / ПРАВАЯ	13-0523-044	
721760 LEVÁ / LEFT / LINKS / ЛЕВАЯ	13-0521-044	

PŘIPOJENÍ / CONNECTION /
ANSCHLUSS / СОЕДИНЕНИЕ



MULTIPOINT IV.

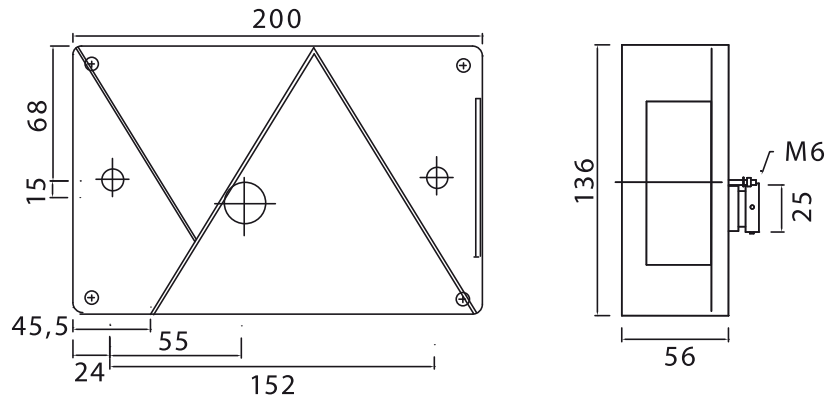

KÓD / ORDER CODE / BESTELL NR. / КОД	OE / OE NUMBER / OE NUMMER / OE	PRAVÁ / RIGHT / RECHTS / ПРАВАЯ	LEVÁ / LEFT / LINKS / ЛЕВАЯ	OSVĚTLENÍ SPZ / ILLUMINATION FOR NUMBERPLATE / KENNZEICHENLEUCHE / ПОДСВЕТКА НОМЕРНОГО ЗНАКА	ZPÁTEČKA / REVERSING LAMP / RÜCKFAHRLEUCHE / ФОНАРЬ ЗАДНЕГО ХОДА	MLHOVKA / REAR FOG LAMP / NEBEL / ПРОТИВОТУМАННАЯ ФАРА
722017	24-8610-007	●		●	●	
722019	24-8400-007		●	●		●
722020 KRYT / LENS / LICHTSCHEIBE / СТЕКЛО ФАРЫ	18-8486-007	●				
722022 KRYT / LENS / LICHTSCHEIBE / СТЕКЛО ФАРЫ	18-8484-007		●			

ŽÁROVKA / BULB /
GLÜHLAMPE / ЛАМПОЧКА

12V	722931	2x	P21W 12V, BA15s
12V	722937	1x	P21 5W 12V, BAY15d
12V	722950	1x	C5W 12V, SV8,5-8
24V	722932	2x	P21W 24V, BA15s
24V	722938	1x	P21 5W 24V, BAY15d
24V	722951	1x	C5W 24V, SV8,5-8

OPRavná SADA / REPAIR KIT /
ANSCHLUSSSATZ / РЕМОНТНЫЙ КОМПЛЕКТ

721761 PRAVÁ / RIGHT / RECHTS / ПРАВАЯ	13-0523-044	
721760 LEVÁ / LEFT / LINKS / ЛЕВАЯ	13-0521-044	

PŘIPOJENÍ / CONNECTION /
ANSCHLUSS / СОЕДИНЕНИЕ



MULTIPOINT V.

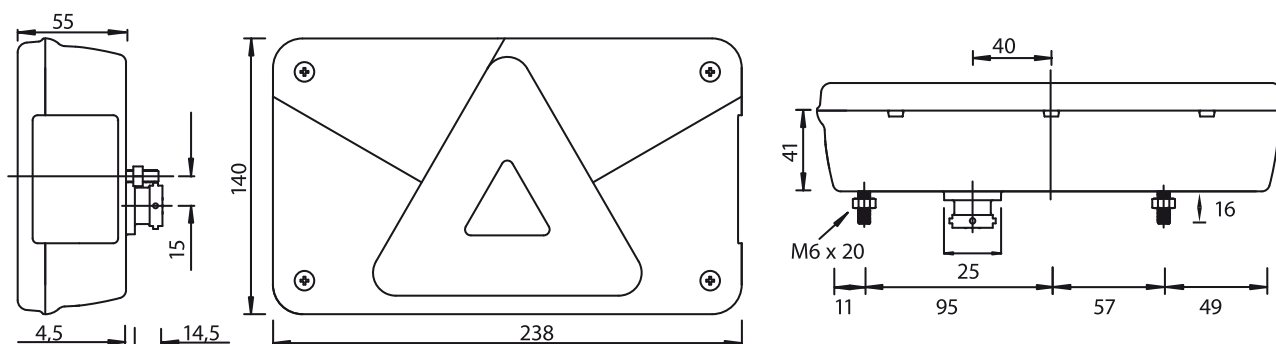

KÓD / ORDER CODE / BESTELL NR. / КОД	OE / OE NUMBER / OE NUMBER / OE	PRAVÁ / RIGHT / RECHTS / ПРАВЯЯ	LEVÁ / LEFT / LINKS / ЛЕВАЯ	OSVĚTLENÍ SPZ / ILLUMINATION FOR NUMBERPLATE / KENNZEICHENLEUCHE / ПОДСВЕТКА НОМЕРНОГО ЗНАКА	ZPÁTEČKA / REVERSING LAMP / RÜCKFAHRLEUCHE / ФОНАРЬ ЗАДНЕГО ХОДА	MLHOVKA / REAR FOG LAMP / NEBEL / ПРОТИВОТУМАННАЯ ФАРА
722023	24-8710-007	●		●	●	
722024	24-8500-007		●	●		●
722025 KRYT / LENS / LICHTSCHEIBE / СТЕКЛО ФАРЫ	18-8487-007	●				
722026 KRYT / LENS / LICHTSCHEIBE / СТЕКЛО ФАРЫ	18-8485-007		●			

ŽÁROVKA / BULB /
GLÜHLAMPE / ЛАМПОЧКА

12V	722943	1x	R10W 12V, BA15s
12V	722931	1x	P21W 12V, BA15s
12V	722934	1x	PY21W 12V, BAU15s
12V	722937	1x	P21 5W 12V, BAY15d
24V	722944	1x	R10W 24V, BA15s
24V	722932	1x	P21W 24V, BA15s
24V	722935	1x	PY21W 24V, BAU15s
24V	722938	1x	P21 5W 24V, BAY15d

OPRÁVNÁ SADA / REPAIR KIT /
ANSCHLUSSSATZ / РЕМОНТНЫЙ КОМПЛЕКТ

721761 PRAVÁ / RIGHT / RECHTS / ПРАВЯЯ	13-0523-044	
721760 LEVÁ / LEFT / LINKS / ЛЕВАЯ	13-0521-044	

PŘIPOJENÍ / CONNECTION /
ANSCHLUSS / СОЕДИНЕНИЕ



AGADOS

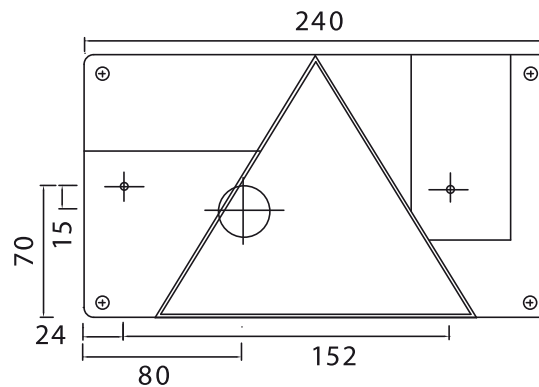

KÓD / ORDER CODE / BESTELL NR. / КОД	OE / OE NUMBER / OE NUMMER / OE	PRAVÁ / RIGHT / RECHTS / ПРАВЯЯ	LEVÁ / LEFT / LINKS / ЛЕВАЯ	OSVĚTLENÍ SPZ / ILLUMINATION FOR NUMBERPLATE / KENNZEICHENLEUCHE / ПОДСВЕТКА НОМЕРНОГО ЗНАКА	ZPÁTEČKA / REVERSING LAMP / RÜCKFAHRLEUCHE / ФОНАРЬ ЗАДНЕГО ХОДА	MLHOVKA / REAR FOG LAMP / NEBEL / ПРОТИВОТУМАННАЯ ФАРА
721223		●		●		
721225			●	●		●
721224 KRYT / LENS / LICHTSCHEIBE / СТЕКЛО ФАРЫ		●		●		
721226 KRYT / LENS / LICHTSCHEIBE / СТЕКЛО ФАРЫ			●	●		●

ŽÁROVKA / BULB /
GLÜHLAMPE / ЛАМПОЧКА

12V	722931	2x	P21W 12V, BA15s
12V	722937	1x	P21 5W 12V, BAY15d
12V	722950	1x	C5W 12V, SV8,5-8
24V	722932	2x	P21W 24V, BA15s
24V	722938	1x	P21 5W 24V, BAY15d
24V	722951	1x	C5W 24V, SV8,5-8

OPRavná SADA / REPAIR KIT /
ANSCHLUSSSATZ / РЕМОНТНЫЙ КОМПЛЕКТ

721761 PRAVÁ / RIGHT / RECHTS / ПРАВЯЯ	13-0523-044	
721760 LEVÁ / LEFT / LINKS / ЛЕВАЯ	13-0521-044	

PŘIPOJENÍ / CONNECTION /
ANSCHLUSS / СОЕДИНЕНИЕ



AGADOS 2008 -

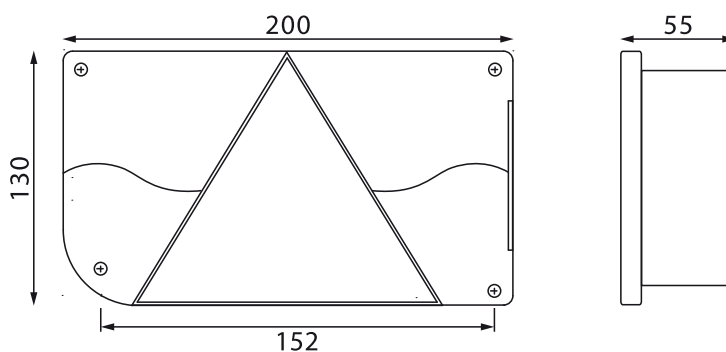

KÓD / ORDER CODE / BESTELL NR. / КОД	OE / OE NUMBER / OE NUMMER / OE	PRAVÁ / RIGHT / RECHTS / ПРАВЯЯ	LEVÁ / LEFT / LINKS / ЛЕВАЯ	OSVĚTLENÍ SPZ / ILLUMINATION FOR NUMBERPLATE / KENNZEICHENLEUCHE / ПОДСВЕТКА НОМЕРНОГО ЗНАКА	ZPÁTEČKA / REVERSING LAMP / RÜCKFAHRLEUCHE / ФОНАРЬ ЗАДНЕГО ХОДА	MLHOVKA / REAR FOG LAMP / NEBEL / ПРОТИВОТУМАННАЯ ФАРА
721262		●		●	●	
721263			●	●		●
721264 KRYT / LENS / LICHTSCHEIBE / СТЕКЛО ФАРЫ		●			●	
721265 KRYT / LENS / LICHTSCHEIBE / СТЕКЛО ФАРЫ			●			●

ŽÁROVKA / BULB /
GLÜHLAMPE / ЛАМПОЧКА

VOLTAGE	CODE	QUANTITY	TYPE
12V	722931	1x	P21W 12V, BA15s
12V	722937	1x	P21 5W 12V, BAY15d
12V	722934	1x	PY21W 12V, BAU15s
24V	722932	1x	P21W 24V, BA15s
24V	722938	1x	P21 5W 24V, BAY15d
24V	722935	1x	PY21W 24V, BAU15s

OPRavná SADA / REPAIR KIT /
ANSCHLUSSSATZ / РЕМОНТНЫЙ КОМПЛЕКТ

721761 PRAVÁ / RIGHT / RECHTS / ПРАВЯЯ	13-0523-044	
721760 LEVÁ / LEFT / LINKS / ЛЕВАЯ	13-0521-044	

PŘIPOJENÍ / CONNECTION /
ANSCHLUSS / СОЕДИНЕНИЕ



ZPÁTEČKA / REVERSING LAMP / RÜCKFAHRLEUCHE / ФОНАРЬ ЗАДНЕГО ХОДА

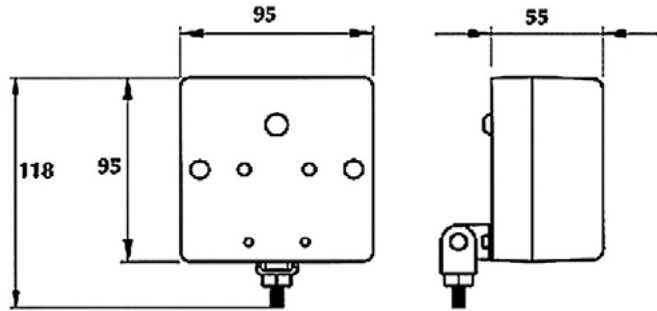

KÓD / ORDER CODE / BESTELL NR. / КОД	OE / OE NUMBER / OE NUMMER / OE	PRAVÁ / RIGHT / RECHTS / ПРАВАЯ	LEVÁ / LEFT / LINKS / ЛЕВАЯ	OSVĚTLENÍ SPZ / ILLUMINATION FOR NUMBERPLATE / KENNZEICHENLEUCHE / ПОДСВЕТКА НОМЕРНОГО ЗНАКА	PŘIPOJENÍ / CONNECTION / ANSCHLUSS / СОЕДИНЕНИЕ
721730		•	•		

ŽÁROVKA / BULB / GLÜHLAMPE / ЛАМПОЧКА

722931	1x	P21W 12V, BA15s
722932	1x	P21W 24V, BA15s

MLHOVKA / REAR FOG LAMP / NEBELSCHLUSSLEUCHE / ПРОТИВОТУМАННАЯ ФАРА

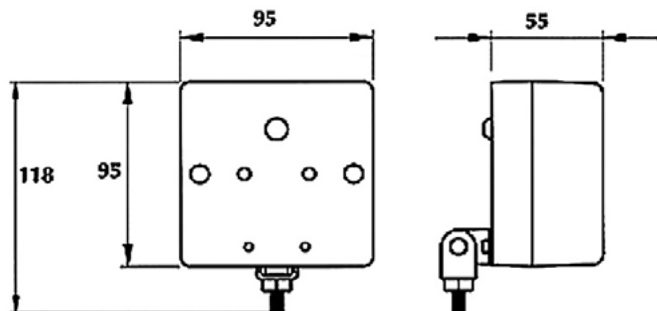





KÓD / ORDER CODE / BESTELL NR. / КОД	OE / OE NUMBER / OE NUMMER / OE	PRAVÁ / RIGHT / RECHTS / ПРАВАЯ	LEVÁ / LEFT / LINKS / ЛЕВАЯ	OSVĚTLENÍ SPZ / ILLUMINATION FOR NUMBERPLATE / KENNZEICHENLEUCHE / ПОДСВЕТКА НОМЕРНОГО ЗНАКА	PŘIPOJENÍ / CONNECTION / ANSCHLUSS / СОЕДИНЕНИЕ
721726		•	•		

ŽÁROVKA / BULB / GLÜHLAMPE / ЛАМПОЧКА

722931	1x	P21W 12V, BA15s
722932	1x	P21W 24V, BA15s

KÓD / ORDER CODE / BESTELL NR. / КОД		POPIS / DESCRIPTION / BESCHREIBUNG / ОПИСАНИЕ	OE / OE NUMBER / OE NUMMER / OE	
721931		12-24 V KONCOVÉ SVĚTLO / TAIL / SCHLUSSLICHT / ЗАДНЯЯ ФАРА	12-1560-001	 
721932		12-24 V SMĚROVÉ SVĚTLO / DIR. INDICATOR / BLINKLICHT / ФАРА ПОВОРОТОВ	12-1560-011	 
721933		12-24 V BRZDOVÉ SVĚTLO / STOP LAMP / BREMSLICHT / ФАРА СТОП СИГНАЛА	12-1560-041	 
721934		12-24 V MLHOVÉ SVĚTLO / FOG LAMP / NEBELSCHLUSSLICHT / ПРОТИВОТУМАННАЯ ФАРА	12-1560-031	 
721935		12-24 V ZPĚTNÉ SVĚTLO / REVERSE LAMP / RÜCKFAHRLICHT / ФАРА ЗАДНЕГО ХОДА	12-1560-021	 

**ANTIKOROZNÍ PASTA / ANTICORROSIVE LIQUIDS /
KORROSIONSSCHUTZMITTEL /
ПРОТИВОКАРРОЗИЙНАЯ ПАСТА**

KÓD / ORDER CODE / BESTELL NR. / КОД		POPIS / DESCRIPTION / BESCHREIBUNG / ОПИСАНИЕ	OE / OE NUMBER / OE NUMMER / OE	NÁKRES / DRAWING / ZEICHNUNG / ЧЕРТЁЖ
720045		57 g	TL/97944	
720035		227 g	TL/97940	



Tato sloučenina je speciálně vyvinutý tmel proti korozi a prevence elektrických rozvodných krabic pro osvětlovací systémy nákladních vozidel a přívěsů.

Sloučenina je speciálně vyvinuta, aby zabránila korozi všech kovů používaných v elektrických přípojkách.



This compound is a specially formulated sealant and corrosion preventive for electrical junction boxes in the lighting systems of trucks and trailers. It has an unctuous, plastic or greasy-like consistency to provide sealing against intrusion of water, rain and road splash into the electrical connections or junction boxes. It will not be affected or lose its sealing efficiency at the high temperatures in hot climates or in the low temperatures experienced in northern areas. The compound is specially formulated to prevent corrosion of all metals used in electrical connections.













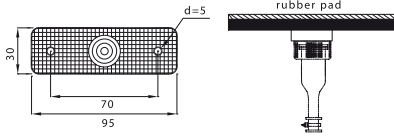

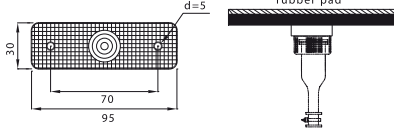
Diese Verbindung ist eine speziell formulierte vorbeugende Versiegelung und Korrosionsschutz für elektrische Verteilerkästen in den Beleuchtungssystemen von LKW und Anhänger. Es verfügt über einen salbungsvollen, Kunststoff oder Fett-artige Konsistenz zur Abdichtung gegen das Eindringen von Wasser, regen - und Straßenbau splash in die elektrischen Anschlüsse oder Verteilerkästen. Es wird nicht beeinflusst werden kann und die Dichtigkeit bei hohen Temperaturen in den heißen Klimazonen oder in den niedrigen Temperaturen in den nördlichen Gebieten Erfahrene. Die Verbindung wurde speziell entwickelt, um Korrosion an allen Metallen im elektrischen Anschlüsse Gebrauchte verhindern.

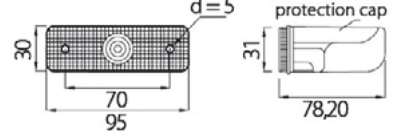

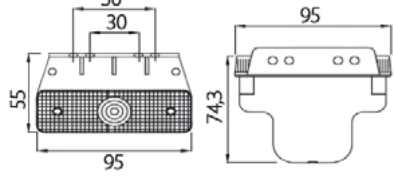
Эта смесь – специальное средство для защиты от коррозии и ее предупреждения на электрических раздаточных коробках системы освещения грузовых машин и прицепов.

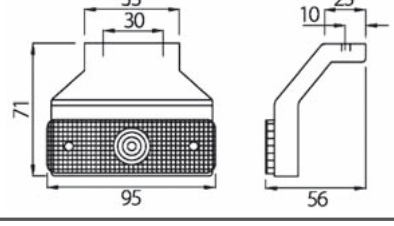
Смесь специально изготовлена для защиты от коррозии металлов, использованных в электрических соединениях.



**POZIČNÍ SVĚTLA / MARKER LAMPS /
POSITIONSLEUCHTEN / ГАБАРИТНЫЕ ЛАМПЫ**

KÓD / ORDER CODE / BESTELL NR. / КОД		POPIS / DESCRIPTION / BESCHREIBUNG / ОПИСАНИЕ	OE / OE NUMBER / OE NUMMER / OE	NÁKRES / DRAWING / ZEICHNUNG / ЧЕРТЁЖ		
723985		SIDEPOINT KABEL / CABLE / KABEL / КАБЕЛЬ - 0,5 m	31-5004-097			
723982		SIDEPOINT KABEL / CABLE / KABEL / КАБЕЛЬ - 3,5 m	31-5004-087			
723984		SIDEPOINT KABEL / CABLE / KABEL / КАБЕЛЬ - 0,5 m	31-5004-007			
723986		SIDEPOINT KABEL / CABLE / KABEL / КАБЕЛЬ - 0,5 m	31-5064-027			
723987		SIDEPOINT KABEL / CABLE / KABEL / КАБЕЛЬ - 0,5 m	31-5064-067			
720477		KABEL / CABLE / KABEL / КАБЕЛЬ - 0,5 m	68-5000-017			
720474		KABEL / CABLE / KABEL / КАБЕЛЬ - 1,5 m	68-5000-037			
721468		P&R / P&R CLICK / P&R KLICKEN / P&R	4260089	722948	12 V	T4W 12V, BA9s
				722949	24 V	T4W 24V, BA9s

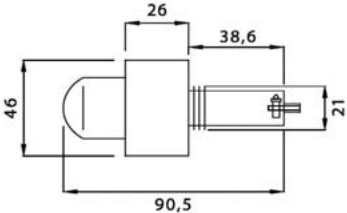
POZIČNÍ SVĚTLA / MARKER LAMPS /
POSITIONSLEUCHTEN / ГАБАРИТНЫЕ ЛАМПЫ

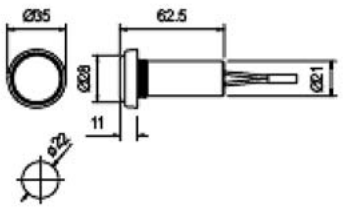

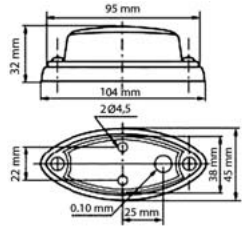
KÓD / ORDER CODE / BESTELL NR. / КОД	POPIS / DESCRIPTION / BESCHREIBUNG / ОПИСАНИЕ	OE / OE NUMBER / OE NUMMER / OE	NÁKRES / DRAWING / ZEICHNUNG / ЧЕРТЁЖ
720058		51 /01 /01	
			722940 12V R5W 12V, BA15s 722941 24V R5W 24V, BA15s

KÓD / ORDER CODE / BESTELL NR. / КОД	POPIS / DESCRIPTION / BESCHREIBUNG / ОПИСАНИЕ	OE / OE NUMBER / OE NUMMER / OE	NÁKRES / DRAWING / ZEICHNUNG / ЧЕРТЁЖ
720371		555 /01 /00	
			722954 12V W3W 12V, W2,1x9,5d 722955 24V W3W 24V, W2,1x9,5d

KÓD / ORDER CODE / BESTELL NR. / КОД	POPIS / DESCRIPTION / BESCHREIBUNG / ОПИСАНИЕ	OE / OE NUMBER / OE NUMMER / OE	NÁKRES / DRAWING / ZEICHNUNG / ЧЕРТЁЖ
721465		02070637	
721466		KRYT / LENS / LICHTSCHEIBE / СТЕКЛО ФАРЫ 02077011	
			722950 12V C5W 12V, SV8,5-8 722951 24V C5W 24V, SV8,5-8



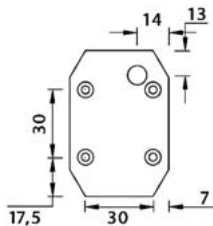



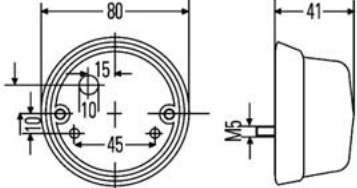

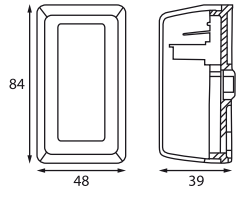

**POZIČNÍ SVĚTLA / MARKER LAMPS /
POSITIONSLEUCHTEN / ГАБАРИТНЫЕ ЛАМПЫ**

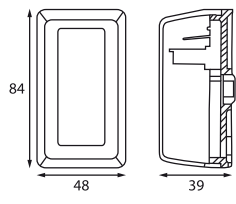
KÓD / ORDER CODE / BESTELL NR. / КОД		POPIS / DESCRIPTION / BESCHREIBUNG / ОПИСАНИЕ	OE / OE NUMBER / OE NUMMER / OE	NÁKRES / DRAWING / ZEICHNUNG / ЧЕРТЁЖ
727380			194130	
727379			194150	
				722948 12V T4W 12V, BA9s 722949 24V T4W 24V, BA9s

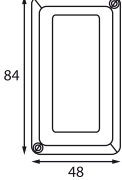

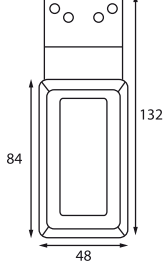
KÓD / ORDER CODE / BESTELL NR. / КОД		POPIS / DESCRIPTION / BESCHREIBUNG / ОПИСАНИЕ	OE / OE NUMBER / OE NUMMER / OE	NÁKRES / DRAWING / ZEICHNUNG / ЧЕРТЁЖ
723983		FLEXIPOINT I. KABEL / CABLE / КАБЕЛЬ / КАБЕЛЬ - 0,3m	31-6504-087	
721468		P&R / P&R CLICK / P&R.KLICKEN / P&R	4260089	722950 12V C5W 12V, SV8,5-8 722951 24V C5W 24V, SV8,5-8

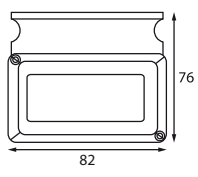

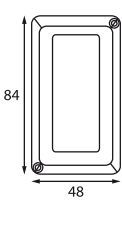
KÓD / ORDER CODE / BESTELL NR. / КОД		POPIS / DESCRIPTION / BESCHREIBUNG / ОПИСАНИЕ	OE / OE NUMBER / OE NUMMER / OE	NÁKRES / DRAWING / ZEICHNUNG / ЧЕРТЁЖ
721803			2PF001259-631	
				722950 12V C5W 12V, SV8,5-8 722951 24V C5W 24V, SV8,5-8



POZIČNÍ SVĚTLA / MARKER LAMPS /
POSITIONSLEUCHTEN / ГАБАРИТНЫЕ ЛАМПЫ

KÓD / ORDER CODE / BESTELL NR. / КОД		POPIS / DESCRIPTION / BESCHREIBUNG / ОПИСАНИЕ	OE / OE NUMBER / OE NUMMER / OE	NÁKRES / DRAWING / ZEICHNUNG / ЧЕРТЁЖ
726862		KRYT / LENS / LICHTSCHEIBE / СТЕКЛО ФАРЫ		
726864		KRYT + ODRAZKA / LENS + REFLEX REFLECTOR / LICHTSCHEIBE + RÜCKSTRAHLER / СТЕКЛО ФАРЫ + СВЕТООТРАЖАТЕЛЬ		
726857		DRŽÁK / HOLDER / HALTER / ДЕРЖАТЕЛЬ		
726860		DRŽÁK / HOLDER / HALTER / ДЕРЖАТЕЛЬ		
726859		DRŽÁK / HOLDER / HALTER / ДЕРЖАТЕЛЬ		
726858		DRŽÁK S TĚSNĚNÍM / HOLDER WITH GASKET / HALTER MIT DICHTUNG / ДЕРЖАТЕЛЬ С ПРОКЛАДКОЙ		
				722940 12V R5W 12V, BA15s 722941 24V R5W 24V, BA15s

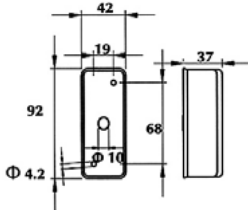

**POZIČNÍ SVĚTLA / MARKER LAMPS /
POSITIONSLEUCHTEN / ГАБАРИТНЫЕ ЛАМПЫ**

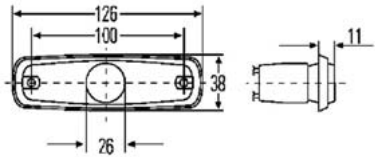



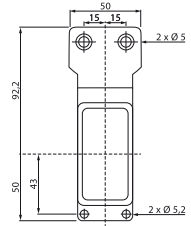

KÓD / ORDER CODE / BESTELL NR. / КОД		POPIS / DESCRIPTION / BESCHREIBUNG / ОПИСАНИЕ	OE / OE NUMBER / OE NUMMER / OE	NÁKRES / DRAWING / ZEICHNUNG / ЧЕРТЁЖ
722833		LAMBERET	510 /01 /08	
722832		LAMBERET - ABS	510ABS /01 /08	
				722940 12V R5W 12V, BA15s 722941 24V R5W 24V, BA15s

KÓD / ORDER CODE / BESTELL NR. / КОД		POPIS / DESCRIPTION / BESCHREIBUNG / ОПИСАНИЕ	OE / OE NUMBER / OE NUMMER / OE	NÁKRES / DRAWING / ZEICHNUNG / ЧЕРТЁЖ
721599				
721646		KRYT / LENS / LICHTSCHEIBE / СТЕКЛО ФАРЫ		
				722940 12V R5W 12V, BA15s 722941 24V R5W 24V, BA15s

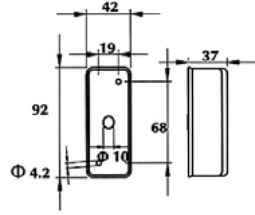

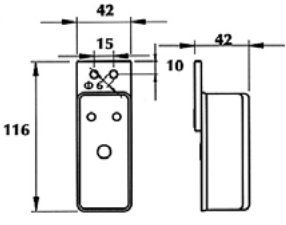

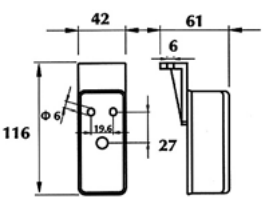

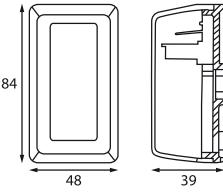

KÓD / ORDER CODE / BESTELL NR. / КОД		POPIS / DESCRIPTION / BESCHREIBUNG / ОПИСАНИЕ	OE / OE NUMBER / OE NUMMER / OE	NÁKRES / DRAWING / ZEICHNUNG / ЧЕРТЁЖ
722724				
720019		OPRAVNÁ SADA / REPAIR KIT / ANSCHLUSSSATZ / РЕМОНТНЫЙ КОМПЛЕКТ		722954 12V W3W 12V, W2,1x9,5d 722955 24V W3W 24V, W2,1x9,5d

POZIČNÍ SVĚTLA / MARKER LAMPS /
POSITIONSLEUCHTEN / ГАБАРИТНЫЕ ЛАМПЫ

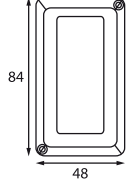

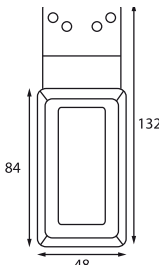

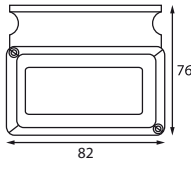

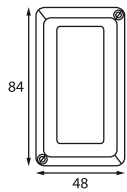
KÓD / ORDER CODE / BESTELL NR. / КОД		POPIS / DESCRIPTION / BESCHREIBUNG / ОПИСАНИЕ	OE / OE NUMBER / OE NUMMER / OE	NÁKRES / DRAWING / ZEICHNUNG / ЧЕРТЁЖ
721358			178340	
721359		KRYT / LENS / LICHTSCHEIBE / СТЕКЛО ФАРЫ	087040	
				722950 12V C5W 12V, SV8,5-8 722951 24V C5W 24V, SV8,5-8

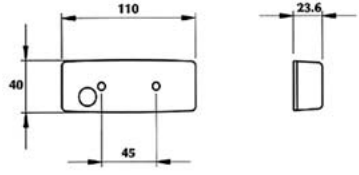

KÓD / ORDER CODE / BESTELL NR. / КОД		POPIS / DESCRIPTION / BESCHREIBUNG / ОПИСАНИЕ	OE / OE NUMBER / OE NUMMER / OE	NÁKRES / DRAWING / ZEICHNUNG / ЧЕРТЁЖ
721595				
721954				
724961				
721638		KRYT / LENS / LICHTSCHEIBE / СТЕКЛО ФАРЫ		
				722940 12V R5W 12V, BA15s 722941 24V R5W 24V, BA15s

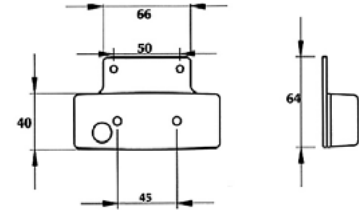
**POZIČNÍ SVĚTLA / MARKER LAMPS /
POSITIONSLEUCHTEN / ГАБАРИТНЫЕ ЛАМПЫ**

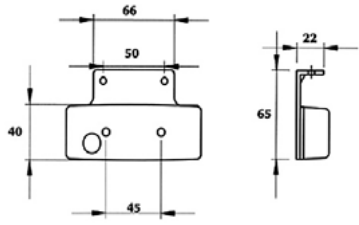
KÓD / ORDER CODE / BESTELL NR. / КОД		POPIS / DESCRIPTION / BESCHREIBUNG / ОПИСАНИЕ	OE / OE NUMBER / OE NUMMER / OE	NÁKRES / DRAWING / ZEICHNUNG / ЧЕРТЁЖ						
726865		KRYT + ODRAZKA / LENS + REFLEX REFLECTOR / LICHTSCHEIBE + RÜCKSTRAHLER / СТЕКЛО ФАРЫ + СВЕТООТРАЖАТЕЛЬ								
726857		DRŽÁK / HOLDER / HALTER / ДЕРЖАТЕЛЬ								
726860		DRŽÁK / HOLDER / HALTER / ДЕРЖАТЕЛЬ								
726859		DRŽÁK / HOLDER / HALTER / ДЕРЖАТЕЛЬ								
726858		DRŽÁK S TĚSNĚNÍM / HOLDER WITH GASKET / HALTER MIT DICHTUNG / ДЕРЖАТЕЛЬ С ПРОКЛАДКОЙ								
				<table border="1"> <tr> <td data-bbox="1045 2011 1157 2045">722940</td> <td data-bbox="1157 2011 1220 2045">12V</td> <td data-bbox="1220 2011 1444 2045">R5W 12V, BA15s</td> </tr> <tr> <td data-bbox="1045 2045 1157 2078">722941</td> <td data-bbox="1157 2045 1220 2078">24V</td> <td data-bbox="1220 2045 1444 2078">R5W 24V, BA15s</td> </tr> </table>	722940	12V	R5W 12V, BA15s	722941	24V	R5W 24V, BA15s
722940	12V	R5W 12V, BA15s								
722941	24V	R5W 24V, BA15s								



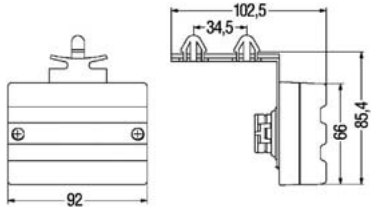

POZIČNÍ SVĚTLA / MARKER LAMPS /
POSITIONSLEUCHTEN / ГАБАРИТНЫЕ ЛАМПЫ

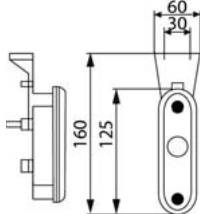

KÓD / ORDER CODE / BESTELL NR. / КОД		POPIS / DESCRIPTION / BESCHREIBUNG / ОПИСАНИЕ	OE / OE NUMBER / OE NUMMER / OE	NÁKRES / DRAWING / ZEICHNUNG / ЧЕРТЁЖ						
721647										
721650										
721652										
721657		KRYT / LENS / LICHTSCHEIBE / СТЕКЛО ФАРЫ								
				<table border="1"> <tr> <td>722954</td> <td>12 V</td> <td>W3W 12V, W2,1x9,5d</td> </tr> <tr> <td>722955</td> <td>24 V</td> <td>W3W 24V, W2,1x9,5d</td> </tr> </table>	722954	12 V	W3W 12V, W2,1x9,5d	722955	24 V	W3W 24V, W2,1x9,5d
722954	12 V	W3W 12V, W2,1x9,5d								
722955	24 V	W3W 24V, W2,1x9,5d								

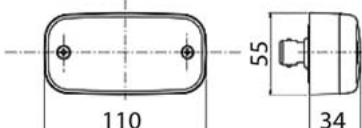
KÓD / ORDER CODE / BESTELL NR. / КОД		POPIS / DESCRIPTION / BESCHREIBUNG / ОПИСАНИЕ	OE / OE NUMBER / OE NUMMER / OE	NÁKRES / DRAWING / ZEICHNUNG / ЧЕРТЁЖ						
721342		S DRŽÁKEM / WITH CLIP HOLDER / MIT KLIPSNKEL LÄHNHS HINTEN / С ДЕРЖАТЕЛЕМ	2PS340000-021							
721343		KRYT / LENS / LICHTSCHEIBE / СТЕКЛО ФАРЫ	9EL340002-011							
				<table border="1"> <tr> <td>722950</td> <td>12 V</td> <td>C5W 12V, SV8,5-8</td> </tr> <tr> <td>722951</td> <td>24 V</td> <td>C5W 24V, SV8,5-8</td> </tr> </table>	722950	12 V	C5W 12V, SV8,5-8	722951	24 V	C5W 24V, SV8,5-8
722950	12 V	C5W 12V, SV8,5-8								
722951	24 V	C5W 24V, SV8,5-8								

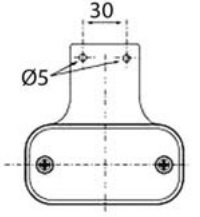

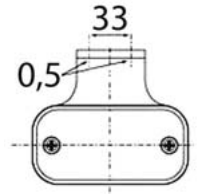

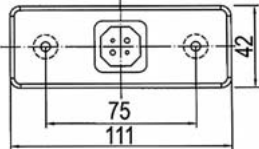

**POZIČNÍ SVĚTLA / MARKER LAMPS /
POSITIONSLEUCHTEN / ГАБАРИТНЫЕ ЛАМПЫ**

KÓD / ORDER CODE / BESTELL NR. / КОД		POPIS / DESCRIPTION / BESCHREIBUNG / ОПИСАНИЕ	OE / OE NUMBER / OE NUMMER / OE	NÁKRES / DRAWING / ZEICHNUNG / ЧЕРТЕЖ
722837		ČERVENÁ + BÍLÁ + ORANŽOVÁ / RED + WHITE + ORANGE / ROT + WEISS + ORANGE / КРАСНАЯ + БЕЛАЯ + ОРАНЖЕВАЯ	597 /01 /00	
				722954 12V W3W 12V, W2,1x9,5d 722955 24V W3W 24V, W2,1x9,5d

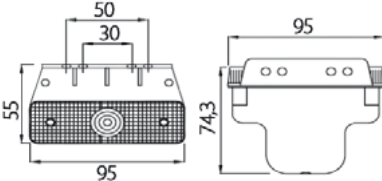
KÓD / ORDER CODE / BESTELL NR. / КОД		POPIS / DESCRIPTION / BESCHREIBUNG / ОПИСАНИЕ	OE / OE NUMBER / OE NUMMER / OE	NÁKRES / DRAWING / ZEICHNUNG / ЧЕРТЕЖ
726985			194010	
726984			194020	
726983			194030	
				722948 12V T4W 12V, BA9s 722949 24V T4W 24V, BA9s

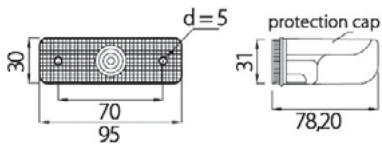
KÓD / ORDER CODE / BESTELL NR. / КОД		POPIS / DESCRIPTION / BESCHREIBUNG / ОПИСАНИЕ	OE / OE NUMBER / OE NUMMER / OE	NÁKRES / DRAWING / ZEICHNUNG / ЧЕРТЕЖ
721272			0028207056	
720010		OPRAVNÁ SADA / REPAIR KIT / ANSCHLUSSSATZ / РЕМОНТНЫЙ КОМПЛЕКТ		722954 12V W3W 12V, W2,1x9,5d 722955 24V W3W 24V, W2,1x9,5d

POZIČNÍ SVĚTLA / MARKER LAMPS /
POSITIONSLEUCHTEN / ГАБАРИТНЫЕ ЛАМПЫ







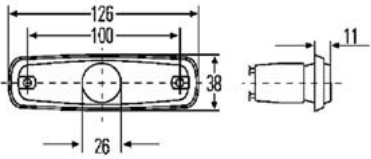

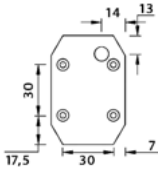

KÓD / ORDER CODE / BESTELL NR. / КОД		POPIS / DESCRIPTION / BESCHREIBUNG / ОПИСАНИЕ	OE / OE NUMBER / OE NUMMER / OE	NÁKRES / DRAWING / ZEICHNUNG / ЧЕРТЁЖ		
724027		SIDEPOINT KABEL / CABLE / KABEL / КАБЕЛЬ - 0,5m	31-2814-007			
724024		SIDEPOINT KABEL / CABLE / KABEL / КАБЕЛЬ - 0,5m	31-2814-047			
720477		KABEL / CABLE / KABEL / КАБЕЛЬ - 0,5m	68-5000-017			
720474		KABEL / CABLE / KABEL / КАБЕЛЬ - 1,5m	68-5000-037			
721468		P&R / P&R CLICK / P&R KLICKEN / P&R	4260089	722948 722949	12V 24V	T4W 12V, BA9s T4W 24V, BA9s

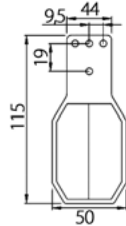

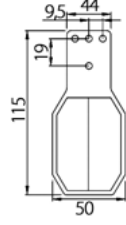
KÓD / ORDER CODE / BESTELL NR. / КОД		POPIS / DESCRIPTION / BESCHREIBUNG / ОПИСАНИЕ	OE / OE NUMBER / OE NUMMER / OE	NÁKRES / DRAWING / ZEICHNUNG / ЧЕРТЁЖ		
720112			193020			
725280		OBJÍMKA / BULB HOLDER / LAMPENFASSUNG / ПАТРОН ЛАМПЫ	001726	722956	12V	W5W 12V, W2,1x9,5d
720006		OPRAVNÁ SADA / REPAIR KIT / ANSCHLUSSSATZ / РЕМОНТНЫЙ КОМПЛЕКТ		722957	24V	W5W 24V, W2,1x9,5d

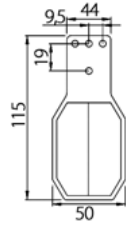
**POZIČNÍ SVĚTLA / MARKER LAMPS /
POSITIONSLEUCHTEN / ГАБАРИТНЫЕ ЛАМПЫ**

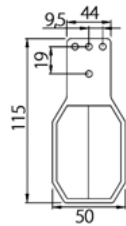
KÓD / ORDER CODE / BESTELL NR. / КОД		POPIS / DESCRIPTION / BESCHREIBUNG / ОПИСАНИЕ	OE / OE NUMBER / OE NUMMER / OE	NÁKRES / DRAWING / ZEICHNUNG / ЧЕРТЁЖ		
722723			2PS962964-012			
				722954	12 V	W3W 12V, W2,1x9,5d
				722955	24 V	W3W 24V, W2,1x9,5d

POZIČNÍ SVĚTLA / MARKER LAMPS /
POSITIONSLEUCHTEN / ГАБАРИТНЫЕ ЛАМПЫ

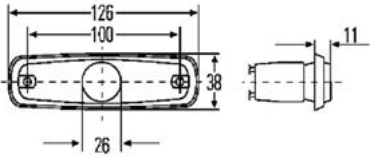





KÓD / ORDER CODE / BESTELL NR. / КОД		POPIS / DESCRIPTION / BESCHREIBUNG / ОПИСАНИЕ	OE / OE NUMBER / OE NUMMER / OE	NÁKRES / DRAWING / ZEICHNUNG / ЧЕРТЁЖ		
724059		FLEXIPOINT I. KABEL / CABLE / KABEL / КАБЕЛЬ - 0,3m	31-6504-177			
723989 PRAVÁ / RIGHT / RECHTS / ПРАВАЯ		FLEXIPOINT I. KABEL / CABLE / KABEL / КАБЕЛЬ - 0,3m	31-6564-067			
723990 LEVÁ / LEFT / LINKS / ЛЕВАЯ		FLEXIPOINT I. KABEL / CABLE / KABEL / КАБЕЛЬ - 0,3m	31-6564-077			
724450 PRAVÁ / RIGHT / RECHTS / ПРАВАЯ		FLEXIPOINT I. KABEL / CABLE / KABEL / КАБЕЛЬ - 1,5m	31-6564-147			
724451 LEVÁ / LEFT / LINKS / ЛЕВАЯ		FLEXIPOINT I. KABEL / CABLE / KABEL / КАБЕЛЬ - 1,5m	31-6564-157			
721468		P&R / P&R CLICK / P&R KLICKEN / P&R	4260089	722950	12 V	C5W 12V, SV8,5-8
				722951	24V	C5W 24V, SV8,5-8



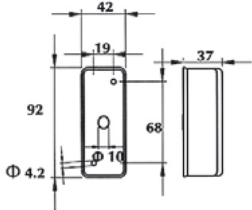

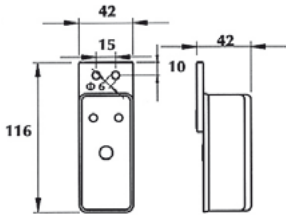
KÓD / ORDER CODE / BESTELL NR. / КОД		POPIS / DESCRIPTION / BESCHREIBUNG / ОПИСАНИЕ	OE / OE NUMBER / OE NUMMER / OE	NÁKRES / DRAWING / ZEICHNUNG / ЧЕРТЁЖ		
722722						
720019		OPRAVNÁ SADA / REPAIR KIT / ANSCHLUSSSATZ / РЕМОНТНЫЙ КОМПЛЕКТ		722954	12 V	W3W 12V, W2,1x9,5d
				722955	24V	W3W 24V, W2,1x9,5d

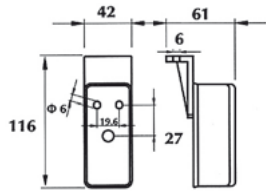
**POZIČNÍ SVĚTLA / MARKER LAMPS /
POSITIONSLEUCHTEN / ГАБАРИТНЫЕ ЛАМПЫ**

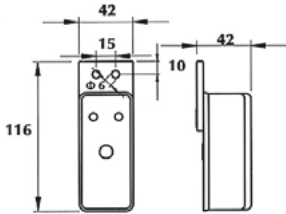

KÓD / ORDER CODE / BESTELL NR. / КОД		POPIS / DESCRIPTION / BESCHREIBUNG / ОПИСАНИЕ	OE / OE NUMBER / OE NUMMER / OE	NÁKRES / DRAWING / ZEICHNUNG / ЧЕРТЁЖ						
726867		KRYT / LENS / LICHTSCHEIBE / СТЕКЛО ФАРЫ								
726857		DRŽÁK / HOLDER / HALTER / ДЕРЖАТЕЛЬ								
726860		DRŽÁK / HOLDER / HALTER / ДЕРЖАТЕЛЬ								
726859		DRŽÁK / HOLDER / HALTER / ДЕРЖАТЕЛЬ								
726858		DRŽÁK S TĚSNĚNÍM / HOLDER WITH GASKET / HALTER MIT DICHTUNG / ДЕРЖАТЕЛЬ С ПРОКЛАДКОЙ								
				<table border="0"> <tr> <td>722940</td> <td>12V</td> <td>R5W 12V, BA15s</td> </tr> <tr> <td>722941</td> <td>24V</td> <td>R5W 24V, BA15s</td> </tr> </table>	722940	12V	R5W 12V, BA15s	722941	24V	R5W 24V, BA15s
722940	12V	R5W 12V, BA15s								
722941	24V	R5W 24V, BA15s								

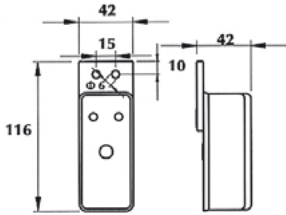



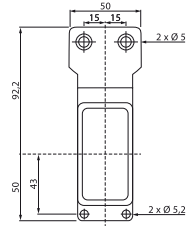

POZIČNÍ SVĚTLA / MARKER LAMPS /
POSITIONSLEUCHTEN / ГАБАРИТНЫЕ ЛАМПЫ

KÓD / ORDER CODE / BESTELL NR. / КОД	POPIS / DESCRIPTION / BESCHREIBUNG / ОПИСАНИЕ	OE / OE NUMBER / OE NUMMER / OE	NÁKRES / DRAWING / ZEICHNUNG / ЧЕРТЁЖ
721589		2XS005020-001	
721602		2XS005020-011	
721616		2XS005020-021	
721636		KRYT / LENS / LICHTSCHEIBE / СТЕКЛО ФАРЫ 9EL132215-001	
			722940 12V R5W 12V, BA15s 722941 24V R5W 24V, BA15s

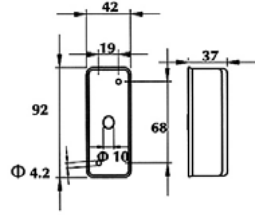
KÓD / ORDER CODE / BESTELL NR. / КОД	POPIS / DESCRIPTION / BESCHREIBUNG / ОПИСАНИЕ	OE / OE NUMBER / OE NUMMER / OE	NÁKRES / DRAWING / ZEICHNUNG / ЧЕРТЁЖ
721603 PRAVÁ / RIGHT / RECHTS / ПРАВАЯ		KABEL / CABLE / KABEL / КАБЕЛЬ - 0,5m 31-4804-037	
721604 LEVÁ / LEFT / LINKS / ЛЕВАЯ		KABEL / CABLE / KABEL / КАБЕЛЬ - 0,5m 31-4804-047	
721468		P&R / P&R CLICK / P&R KLICKEN / P&R 4260089	722940 12V R5W 12V, BA15s 722941 24V R5W 24V, BA15s

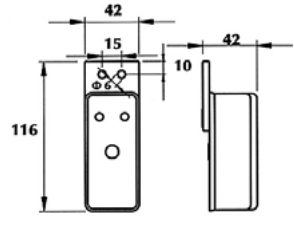

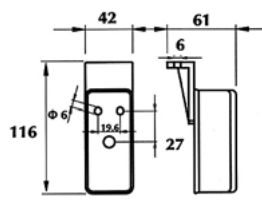
**POZIČNÍ SVĚTLA / MARKER LAMPS /
POSITIONSLEUCHTEN / ГАБАРИТНЫЕ ЛАМПЫ**

KÓD / ORDER CODE / BESTELL NR. / КОД		POPIS / DESCRIPTION / BESCHREIBUNG / ОПИСАНИЕ	OE / OE NUMBER / OE NUMMER / OE	NÁKRES / DRAWING / ZEICHNUNG / ЧЕРТЁЖ
722030			188010	
722031		KRYT / LENS / LICHTSCHEIBE / СТЕКЛО ФАРЫ	088010	
				722950 12V C5W 12V, SV8,5-8 722951 24V C5W 24V, SV8,5-8

KÓD / ORDER CODE / BESTELL NR. / КОД		POPIS / DESCRIPTION / BESCHREIBUNG / ОПИСАНИЕ	OE / OE NUMBER / OE NUMMER / OE	NÁKRES / DRAWING / ZEICHNUNG / ЧЕРТЁЖ
721594				
721572				
721631				
721640		KRYT / LENS / LICHTSCHEIBE / СТЕКЛО ФАРЫ		
				722940 12V R5W 12V, BA15s 722941 24V R5W 24V, BA15s

POZIČNÍ SVĚTLA / MARKER LAMPS /
POSITIONSLEUCHTEN / ГАБАРИТНЫЕ ЛАМПЫ

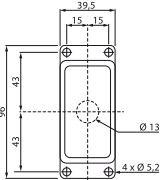
KÓD / ORDER CODE / BESTELL NR. / КОД		POPIS / DESCRIPTION / BESCHREIBUNG / ОПИСАНИЕ	OE / OE NUMBER / OE NUMMER / OE	NÁKRES / DRAWING / ZEICHNUNG / ЧЕРТЁЖ		
723988		FLEXIPOINT I. KABEL / CABLE / KABEL / КАБЕЛЬ - 0,3m	31-6504-107			
723936		FLEXIPOINT I. KABEL / CABLE / KABEL / КАБЕЛЬ - 0,5m	31-6564-237			
721468		P&R / P&R CLICK / P&R.KLICKEN / P&R	4260089	722950	12V	C5W 12V, SV8,5-8
				722951	24V	C5W 24V, SV8,5-8



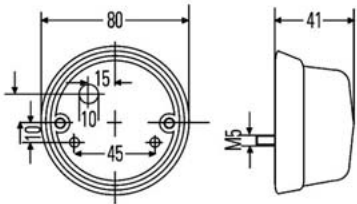

KÓD / ORDER CODE / BESTELL NR. / КОД		POPIS / DESCRIPTION / BESCHREIBUNG / ОПИСАНИЕ	OE / OE NUMBER / OE NUMMER / OE	NÁKRES / DRAWING / ZEICHNUNG / ЧЕРТЁЖ		
721302			187730			
721289		KRYT / LENS / LICHTSCHEIBE / СТЕКЛО ФАРЫ	087030			
				722950	12V	C5W 12V, SV8,5-8
				722951	24V	C5W 24V, SV8,5-8

KÓD / ORDER CODE / BESTELL NR. / КОД		POPIS / DESCRIPTION / BESCHREIBUNG / ОПИСАНИЕ	OE / OE NUMBER / OE NUMMER / OE	NÁKRES / DRAWING / ZEICHNUNG / ЧЕРТЁЖ		
721804			2SA001259-751			
				722950	12V	C5W 12V, SV8,5-8
				722951	24V	C5W 24V, SV8,5-8

POZIČNÍ SVĚTLA / MARKER LAMPS /
POSITIONSLEUCHTEN / ГАБАРИТНЫЕ ЛАМПЫ

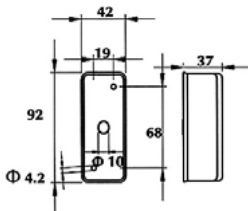

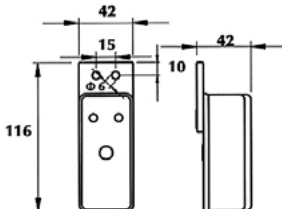

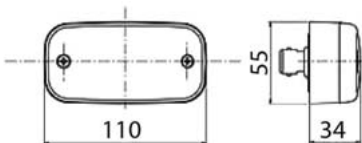

KÓD / ORDER CODE / BESTELL NR. / КОД		POPIS / DESCRIPTION / BESCHREIBUNG / ОПИСАНИЕ	OE / OE NUMBER / OE NUMMER / OE	NÁKRES / DRAWING / ZEICHNUNG / ЧЕРТЁЖ
726861		KRYT / LENS / LICHTSCHEIBE / СТЕКЛО ФАРЫ		
726866		KRYT / LENS / LICHTSCHEIBE / СТЕКЛО ФАРЫ		
726857		DRŽÁK / HOLDER / HALTER / ДЕРЖАТЕЛЬ		
726860		DRŽÁK / HOLDER / HALTER / ДЕРЖАТЕЛЬ		
726859		DRŽÁK / HOLDER / HALTER / ДЕРЖАТЕЛЬ		
726858		DRŽÁK S TĚSNĚNÍM / HOLDER WITH GASKET / HALTER MIT DICHTUNG / ДЕРЖАТЕЛЬ С ПРОКЛАДКОЙ		
				722940 12V R5W 12V, BA15s 722941 24V R5W 24V, BA15s

POZIČNÍ SVĚTLA / MARKER LAMPS /
POSITIONSLEUCHTEN / ГАБАРИТНЫЕ ЛАМПЫ

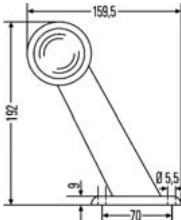
KÓD / ORDER CODE / BESTELL NR. / КОД		POPIS / DESCRIPTION / BESCHREIBUNG / ОПИСАНИЕ	OE / OE NUMBER / OE NUMMER / OE	NÁKRES / DRAWING / ZEICHNUNG / ЧЕРТЁЖ
721582			2XS005020-041	
721607			2XS005020-091	
721635		KRYT / LENS / LICHTSCHEIBE / СТЕКЛО ФАРЫ	9EL132215-011	
				722940 12V R5W 12V, BA15s 722941 24V R5W 24V, BA15s

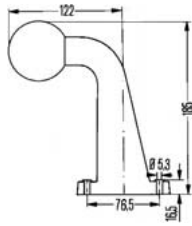

KÓD / ORDER CODE / BESTELL NR. / КОД		POPIS / DESCRIPTION / BESCHREIBUNG / ОПИСАНИЕ	OE / OE NUMBER / OE NUMMER / OE	NÁKRES / DRAWING / ZEICHNUNG / ЧЕРТЁЖ
727381			194310	
				722948 12V T4W 12V, BA9s 722949 24V T4W 24V, BA9s

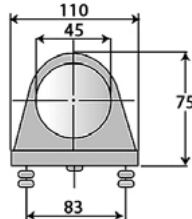

OBRYSOVÁ SVĚTLA / OUTLINE MARKER LAMPS / UMRISSLEUCHTEN / КОНТУРНЫЕ ЛАМПЫ

KÓD / ORDER CODE / BESTELL NR. / КОД		POPIS / DESCRIPTION / BESCHREIBUNG / ОПИСАНИЕ	OE / OE NUMBER / OE NUMMER / OE	NÁKRES / DRAWING / ZEICHNUNG / ЧЕРТЁЖ
720255		ČERVENÁ + BÍLÁ, PRYZOVÉ RAMENO 60°, KABEL - 0,15 m / RED + WHITE, RUBBER ARM 60°, CABLE - 0,15 m / ROT + WEISS, GUMMIARM 60°, KABEL - 0,15 m / КРАСНАЯ + БЕЛАЯ, РЕЗИНОВЫЙ РУКАВ 60°, КАБЕЛЬ - 0,15 м		
720254		ČERVENÁ + BÍLÁ, PRYZOVÉ RAMENO 90°, KABEL - 0,15 m / RED + WHITE, RUBBER ARM 90°, CABLE - 0,15 m / ROT + WEISS, GUMMIARM 90°, KABEL - 0,15 m / КРАСНАЯ + БЕЛАЯ, РЕЗИНОВЫЙ РУКАВ 90°, КАБЕЛЬ - 0,15 м		
727236		ČERVENÉ SKLO / RED GLASS / ROT GLAS / КРАСНОЕ СТЕКЛО		
727235		ČIRÉ SKLO / CLEAR GLASS / KLAR GLAS / ПРОЗРАЧНОЕ СТЕКЛО		
727207		OBJÍMKA + KABEL / BULB HOLDER + CABLE FOR OUTLINE MARKER / LAMPENFASSUNG + KABEL FÜR UMRIS / ПАТРОН ЛАМПЫ + ПРОВОД		
				722940 12 V R5W 12V, BA15s 722941 24 V R5W 24V, BA15s

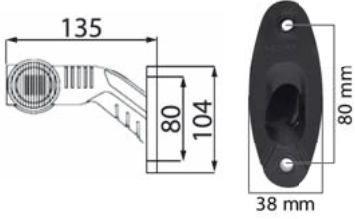

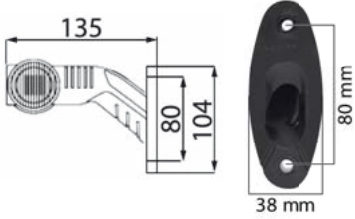

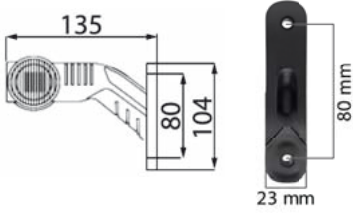

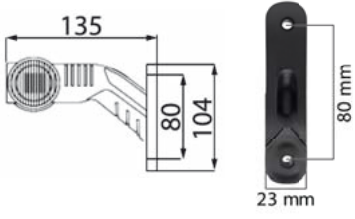
KÓD / ORDER CODE / BESTELL NR. / КОД		POPIS / DESCRIPTION / BESCHREIBUNG / ОПИСАНИЕ	OE / OE NUMBER / OE NUMMER / OE	NÁKRES / DRAWING / ZEICHNUNG / ЧЕРТЁЖ
720411		ČERVENÁ + BÍLÁ, KABEL - 0,15 m / RED + WHITE, CABLE - 0,15 m / ROT + WEISS, KABEL - 0,15 m / КРАСНАЯ + БЕЛАЯ, КАБЕЛЬ - 0,15 м		
				722940 12 V R5W 12V, BA15s 722941 24 V R5W 24V, BA15s

OBRYSOVÁ SVĚTLA / OUTLINE MARKER LAMPS / UMRISSLEUCHTEN / КОНТУРНЫЕ ЛАМПЫ

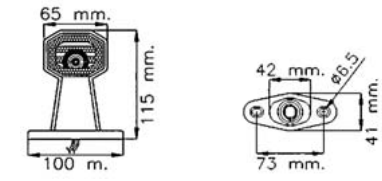

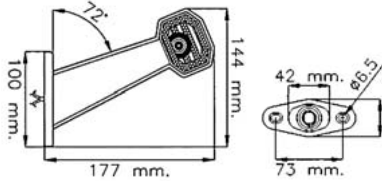

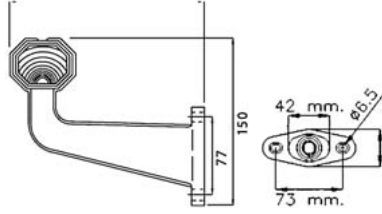

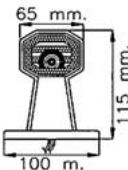
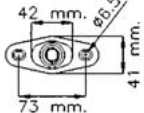

KÓD / ORDER CODE / BESTELL NR. / КОД		POPIS / DESCRIPTION / BESCHREIBUNG / ОПИСАНИЕ	OE / OE NUMBER / OE NUMMER / OE	NÁKRES / DRAWING / ZEICHNUNG / ЧЕРТЁЖ
725520 PRAVÁ / RIGHT / RECHTS / ПРАВАЯ		ČERVENÁ + BÍLÁ + ORANŽOVÁ, KABEL - 0,1 m / RED + WHITE + ORANGE, CABLE - 0,1 m / ROT + WEISS + ORANGE, KABEL - 0,1 m / КРАСНАЯ + БЕЛАЯ + ОРАНЖЕВАЯ, КАБЕЛЬ - 0,1 м	31-3306-067	
725521 LEVÁ / LEFT / LINKS / ЛЕВАЯ		ČERVENÁ + BÍLÁ + ORANŽOVÁ, KABEL - 0,1 m / RED + WHITE + ORANGE, CABLE - 0,1 m / ROT + WEISS + ORANGE, KABEL - 0,1 m / КРАСНАЯ + БЕЛАЯ + ОРАНЖЕВАЯ, КАБЕЛЬ - 0,1 м	31-3305-067	
				722948 12V T4W 12V, BA9s 722949 24V T4W 24V, BA9s

KÓD / ORDER CODE / BESTELL NR. / КОД		POPIS / DESCRIPTION / BESCHREIBUNG / ОПИСАНИЕ	OE / OE NUMBER / OE NUMMER / OE	NÁKRES / DRAWING / ZEICHNUNG / ЧЕРТЁЖ
725523 PRAVÁ / RIGHT / RECHTS / ПРАВАЯ		ČERVENÁ + BÍLÁ + ORANŽOVÁ, KABEL - 0,1 m / RED + WHITE + ORANGE, CABLE - 0,1 m / ROT + WEISS + ORANGE, KABEL - 0,1 m / КРАСНАЯ + БЕЛАЯ + ОРАНЖЕВАЯ, КАБЕЛЬ - 0,1 м	31-3302-027	
725522 LEVÁ / LEFT / LINKS / ЛЕВАЯ		ČERVENÁ + BÍLÁ + ORANŽOVÁ, KABEL - 0,1 m / RED + WHITE + ORANGE, CABLE - 0,1 m / ROT + WEISS + ORANGE, KABEL - 0,1 m / КРАСНАЯ + БЕЛАЯ + ОРАНЖЕВАЯ, КАБЕЛЬ - 0,1 м	31-3303-027	
				722948 12V T4W 12V, BA9s 722949 24V T4W 24V, BA9s

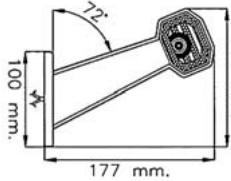
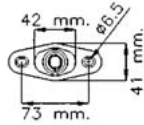

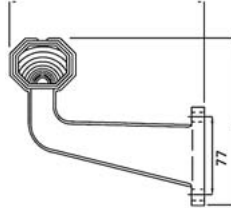
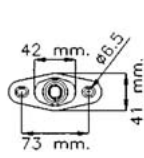







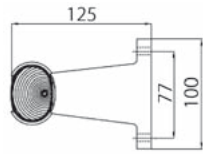

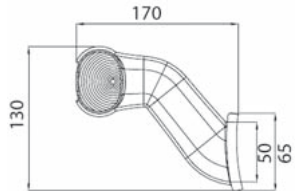
OBRYSOVÁ SVĚTLA / OUTLINE MARKER LAMPS / UMRISSLEUCHTEN / КОНТУРНЫЕ ЛАМПЫ

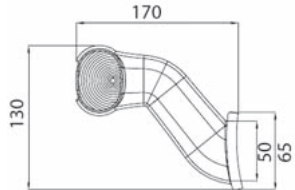
KÓD / ORDER CODE / BESTELL NR. / КОД		POPIS / DESCRIPTION / BESCHREIBUNG / ОПИСАНИЕ	OE / OE NUMBER / OE NUMMER / OE	NÁKRES / DRAWING / ZEICHNUNG / ЧЕРТЁЖ						
721428		ČERVENÁ + BÍLÁ, PRYZOVÉ RAMENO, KABEL - 0,5m / RED + WHITE, RUBBER ARM, CABLE - 0,5m / ROT + WEISS, GUMMIARM, KABEL - 0,5m / КРАСНАЯ + БЕЛАЯ, РЕЗИНОВЫЙ РУКАВ, КАБЕЛЬ - 0,5м								
721430		ČERVENÁ + BÍLÁ, PRYZOVÉ RAMENO 60°, KABEL - 0,5m / RED + WHITE, RUBBER ARM 60°, CABLE - 0,5m / ROT + WEISS, GUMMIARM 60°, KABEL - 0,5m / КРАСНАЯ + БЕЛАЯ, РЕЗИНОВЫЙ РУКАВ 60°, КАБЕЛЬ - 0,5м								
721429		ČERVENÁ + BÍLÁ, PRYZOVÉ RAMENO 90°, KABEL - 0,5m / RED + WHITE, RUBBER ARM 90°, CABLE - 0,5m / ROT + WEISS, GUMMIARM 90°, KABEL - 0,5m / КРАСНАЯ + БЕЛАЯ, РЕЗИНОВЫЙ РУКАВ 90°, КАБЕЛЬ - 0,5м	31-3503-087 31-3502-087							
721488		SKLO + OBJÍMKA + KABEL - 0,7 m / GLASS + BULB HULB HOLDER + CABLE - 0,7 m / GLAS + LAMPENFASSUNG + KABEL - 0,7 m / СТЕКЛО + ПАТРОН ЛАМПЫ + ПРОВОД - 0,7м	21-3500-004							
721501		SKLO ČERNOBÍLÉ / GLASS BLACK, WHITE / GLAS, SCHWARZ, WEISS / СТЕКЛО ЧЕРНО-БЕЛОЕ	18-8135-027							
				<table border="1"> <tr> <td>722956</td> <td>12 V</td> <td>W5W 12V, W2,1x9,5d</td> </tr> <tr> <td>722957</td> <td>24 V</td> <td>W5W 24V, W2,1x9,5d</td> </tr> </table>	722956	12 V	W5W 12V, W2,1x9,5d	722957	24 V	W5W 24V, W2,1x9,5d
722956	12 V	W5W 12V, W2,1x9,5d								
722957	24 V	W5W 24V, W2,1x9,5d								

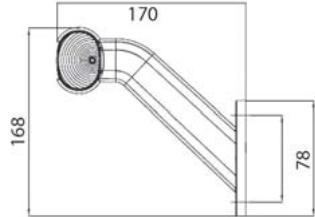

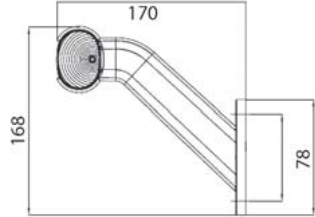



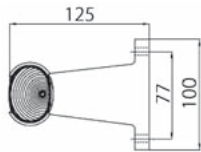

OBRYSOVÁ SVĚTLA / OUTLINE MARKER LAMPS / UMRISSLEUCHTEN / КОНТУРНЫЕ ЛАМПЫ

KÓD / ORDER CODE / BESTELL NR. / КОД		POPIS / DESCRIPTION / BESCHREIBUNG / ОПИСАНИЕ	OE / OE NUMBER / OE NUMMER / OE	NÁKRES / DRAWING / ZEICHNUNG / ЧЕРТЁЖ		
721458		ČERVENÁ + BÍLÁ, PRYZOVÉ RAMENO, P&R KABEL - 0,5m / RED + WHITE, RUBBER ARM, P&R CABLE - 0,5m / ROT + WEISS, GUMMIARM, P&R KABEL - 0,5m / КРАСНАЯ + БЕЛАЯ, РЕЗИНОВЫЙ РУКАВ, P&R КАБЕЛЬ - 0,5м				
721457		ČERVENÁ + BÍLÁ, PRYZOVÉ RAMENO 60°, P&R KABEL - 0,5m / RED + WHITE, RUBBER ARM 60°, P&R CABLE - 0,5m / ROT + WEISS, GUMMIARM 60°, P&R KABEL - 0,5m / КРАСНАЯ + БЕЛАЯ, РЕЗИНОВЫЙ РУКАВ 60°, P&R КАБЕЛЬ - 0,5м				
721456		ČERVENÁ + BÍLÁ, PRYZOVÉ RAMENO 90°, P&R KABEL - 0,5m / RED + WHITE, RUBBER ARM 90°, P&R CABLE - 0,5m / ROT + WEISS, GUMMIARM 90°, P&R KABEL - 0,5m / КРАСНАЯ + БЕЛАЯ, РЕЗИНОВЫЙ РУКАВ 90°, P&R КАБЕЛЬ - 0,5м	31-3504-167 31-3504-107			
721303		SKLO + OBJÍMKA + P&R KABEL - 0,7 m / GLASS + BULB HULB HOLDER + P&R CABLE - 0,7 m / GLAS + LAMPENFASSUNG + P&R KABEL - 0,7 m / СТЕКЛО + ПАТРОН ЛАМПЫ + P&R ПРОВОД - 0,7м	18-8135-007			
721501		SKLO ČERNOBÍLÉ / GLASS BLACK, WHITE / GLAS, SCHWARZ, WEISS / СТЕКЛО ЧЕРНО-БЕЛОЕ	18-8135-027			
721468		P&R / P&R CLICK / P&R KLICKEN / P&R	4260089	722956 722957	12 V 24 V	W5W 12V, W2,1x9,5d W5W 24V, W2,1x9,5d

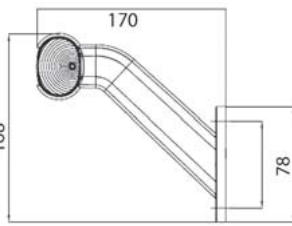
OBRYSOVÁ SVĚTLA / OUTLINE MARKER LAMPS / UMRISSLEUCHTEN / КОНТУРНЫЕ ЛАМПЫ

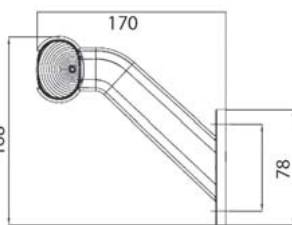

KÓD / ORDER CODE / BESTELL NR. / КОД		POPIS / DESCRIPTION / BESCHREIBUNG / ОПИСАНИЕ	OE / OE NUMBER / OE NUMMER / OE	NÁKRES / DRAWING / ZEICHNUNG / ЧЕРТЁЖ
726823		ČERVENÁ + BÍLÁ + ORANŽOVÁ, PRYZOVÉ RAMENO, KABEL - 0,7m / RED + WHITE + ORANGE, RUBBER ARM, CABLE - 0,7m / ROT + WEISS + ORANGE, GUMMIARM, KABEL - 0,7m / КРАСНАЯ + БЕЛАЯ + ОРАНЖЕВАЯ, РЕЗИНОВЫЙ РУКАВ, КАБЕЛЬ - 0,7м		
726824 PRAVÁ / RIGHT / RECHTS / ПРАВАЯ		ČERVENÁ + BÍLÁ + ORANŽOVÁ, PRYZOVÉ RAMENO, KABEL - 0,7m / RED + WHITE + ORANGE, RUBBER ARM, CABLE - 0,7m / ROT + WEISS + ORANGE, GUMMIARM, KABEL - 0,7m / КРАСНАЯ + БЕЛАЯ + ОРАНЖЕВАЯ, РЕЗИНОВЫЙ РУКАВ, КАБЕЛЬ - 0,7м		
726825 LEVÁ / LEFT / LINKS / ЛЕВАЯ		ČERVENÁ + BÍLÁ + ORANŽOVÁ, PRYZOVÉ RAMENO, KABEL - 0,7m / RED + WHITE + ORANGE, RUBBER ARM, CABLE - 0,7m / ROT + WEISS + ORANGE, GUMMIARM, KABEL - 0,7m / КРАСНАЯ + БЕЛАЯ + ОРАНЖЕВАЯ, РЕЗИНОВЫЙ РУКАВ, КАБЕЛЬ - 0,7м		
726820 PRAVÁ / RIGHT / RECHTS / ПРАВАЯ		ČERVENÁ + BÍLÁ + ORANŽOVÁ, PRYZOVÉ RAMENO, KABEL - 0,7m / RED + WHITE + ORANGE, RUBBER ARM, CABLE - 0,7m / ROT + WEISS + ORANGE, GUMMIARM, KABEL - 0,7m / КРАСНАЯ + БЕЛАЯ + ОРАНЖЕВАЯ, РЕЗИНОВЫЙ РУКАВ, КАБЕЛЬ - 0,7м		
726821 LEVÁ / LEFT / LINKS / ЛЕВАЯ		ČERVENÁ + BÍLÁ + ORANŽOVÁ, PRYZOVÉ RAMENO, KABEL - 0,7m / RED + WHITE + ORANGE, RUBBER ARM, CABLE - 0,7m / ROT + WEISS + ORANGE, GUMMIARM, KABEL - 0,7m / КРАСНАЯ + БЕЛАЯ + ОРАНЖЕВАЯ, РЕЗИНОВЫЙ РУКАВ, КАБЕЛЬ - 0,7м		
721531		SKLO, ČERVENÉ + BÍLÉ + ORANŽOVÉ / GLASS, RED + WHITE + ORANGE / GLAS, ROT + WEISS + ORANGE / СТЕКЛО КРАСНО + БЕЛО + ОРАНЖЕВОЕ	18-8136-007	
721532		SKLO, ČERNÉ + BÍLÉ + ORANŽOVÉ / GLASS, BLACK + WHITE + ORANGE / GLAS, SCHWARZ + WEISS + ORANGE / СТЕКЛО, ЧЕРНО + БЕЛО + ОРАНЖЕВОЕ	18-8137-007	
725386		OBJÍMKA + KABEL - 0,5m / BULB HOLDER + CABLE - 0,5m / LAMPENFASSUNG + KABEL - 0,5m / ПАТРОН ЛАМПЫ + ПРОВОД - 0,5м	31-2800-007	
725387		OBJÍMKA + KABEL - 2m / BULB HOLDER + CABLE - 2m / LAMPENFASSUNG + KABEL - 2m / ПАТРОН ЛАМПЫ + ПРОВОД - 2м	31-2800-027	
				722948 12V T4W 12V, BA9s 722949 24V T4W 24V, BA9s

OBRYSOVÁ SVĚTLA / OUTLINE MARKER LAMPS / UMRISSLEUCHTEN / КОНТУРНЫЕ ЛАМПЫ

KÓD / ORDER CODE / BESTELL NR. / КОД		POPIS / DESCRIPTION / BESCHREIBUNG / ОПИСАНИЕ	OE / OE NUMBER / OE NUMMER / OE	NÁKRES / DRAWING / ZEICHNUNG / ЧЕРТЁЖ		
726822		ČERVENÁ + BILÁ + ORANŽOVÁ, PRYZOVÉ RAMENO, P&R KABEL - 0,7 m / RED + WHITE + ORANGE, RUBBER ARM, P&R CABLE - 0,7 m / ROT + WEISS + ORANGE, GUMMIARM, P&R KABEL - 0,7 m / КРАСНАЯ + БЕЛАЯ + ОРАНЖЕВАЯ, РЕЗИНОВЫЙ РУКАВ, P&R КАБЕЛЬ - 0,7 м				
726818 PRAVÁ / RIGHT / RECHTS / ПРАВАЯ		ČERVENÁ + BILÁ + ORANŽOVÁ, PRYZOVÉ RAMENO, P&R KABEL - 0,7 m / RED + WHITE + ORANGE, RUBBER ARM, P&R CABLE - 0,7 m / ROT + WEISS + ORANGE, GUMMIARM, P&R KABEL - 0,7 m / КРАСНАЯ + БЕЛАЯ + ОРАНЖЕВАЯ, РЕЗИНОВЫЙ РУКАВ, P&R КАБЕЛЬ - 0,7 м				
726819 LEVÁ / LEFT / LINKS / ЛЕВАЯ		ČERVENÁ + BILÁ + ORANŽOVÁ, PRYZOVÉ RAMENO, P&R KABEL - 0,7 m / RED + WHITE + ORANGE, RUBBER ARM, P&R CABLE - 0,7 m / ROT + WEISS + ORANGE, GUMMIARM, P&R KABEL - 0,7 m / КРАСНАЯ + БЕЛАЯ + ОРАНЖЕВАЯ, РЕЗИНОВЫЙ РУКАВ, P&R КАБЕЛЬ - 0,7 м				
721531		SKLO, ČERVENÉ + BILÉ + ORANŽOVÉ / GLASS, RED + WHITE + ORANGE / GLAS, ROT + WEISS + ORANGE / СТЕКЛО КРАСНО + БЕЛО + ОРАНЖЕВОЕ	18-8136-007			
721532		SKLO, ČERNÉ + BILÉ + ORANŽOVÉ / GLASS, BLACK + WHITE + ORANGE / GLAS, SCHWARZ + WEISS + ORANGE / СТЕКЛО, ЧЕРНО + БЕЛО + ОРАНЖЕВОЕ	18-8137-007			
721468		P&R / P&R CLICK / P&R KLICKEN / P&R	4260089	722948	12V	T4W 12V, BA9s
				722949	24V	T4W 24V, BA9s

OBRYSOVÁ SVĚTLA / OUTLINE MARKER LAMPS / UMRISSLEUCHTEN / КОНТУРНЫЕ ЛАМПЫ

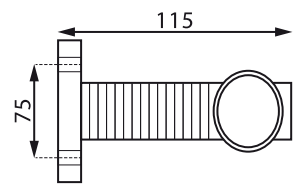
KÓD / ORDER CODE / BESTELL NR. / КОД		POPIS / DESCRIPTION / BESCHREIBUNG / ОПИСАНИЕ	OE / OE NUMBER / OE NUMMER / OE	NÁKRES / DRAWING / ZEICHNUNG / ЧЕРТЁЖ
720611 PRAVÁ / RIGHT / RECHTS / ПРАВАЯ		ČERVENÁ + BILÁ + ORANŽOVÁ, KABEL - 0,5m / RED + WHITE + ORANGE, CABLE - 0,5m / ROT + WEISS + ORANGE, KABEL - 0,5m / КРАСНАЯ + БЕЛАЯ + ОРАНЖЕВАЯ, КАБЕЛЬ - 0,5м	2XS340827-001	
720613 LEVÁ / LEFT / LINKS / ЛЕВАЯ		ČERVENÁ + BILÁ + ORANŽOVÁ, KABEL - 0,5m / RED + WHITE + ORANGE, CABLE - 0,5m / ROT + WEISS + ORANGE, KABEL - 0,5m / КРАСНАЯ + БЕЛАЯ + ОРАНЖЕВАЯ, КАБЕЛЬ - 0,5м	2XS340827-011	
				722948 12V T4W 12V, BA9s 722949 24V T4W 24V, BA9s

KÓD / ORDER CODE / BESTELL NR. / КОД		POPIS / DESCRIPTION / BESCHREIBUNG / ОПИСАНИЕ	OE / OE NUMBER / OE NUMMER / OE	NÁKRES / DRAWING / ZEICHNUNG / ЧЕРТЁЖ
721364		LAMBERET ČERVENÁ + BILÁ + ORANŽOVÁ, PRYŽOVÉ RAMENO, P&R KABEL - 0,85m / RED + WHITE + ORANGE, RUBBER ARM, P&R CABLE - 0,85m / ROT + WEISS + ORANGE, GUMMIARM, P&R KABEL - 0,85m / КРАСНАЯ + БЕЛАЯ + ОРАНЖЕВАЯ, РЕЗИНОВЫЙ РУКАВ, P&R КАБЕЛЬ - 0,85м	D12428	
721468		P&R / P&R CLICK / P&R KLICKEN / P&R	4260089	722956 12V W5W 12V, W2,1x9,5d 722957 24V W5W 24V, W2,1x9,5d





**LED POZIČNÍ SVĚTLA 12V / LED 12V MARKER LAMPS /
LED 12V POSITIONSLEUCHTEN / ДИОДНЫЕ ГАБАРИТНЫЕ ЛАМПЫ 12V**

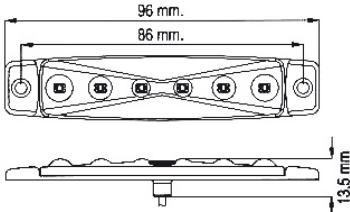

KÓD / ORDER CODE / BESTELL NR. / КОД	POPIS / DESCRIPTION / BESCHREIBUNG / ОПИСАНИЕ	OE / OE NUMBER / OE NUMMER / OE	NÁKRES / DRAWING / ZEICHNUNG / ЧЕРТЁЖ
721969	<p>6x LED, KABEL - 0,7m /</p> <p>6x LEDs, CABLE - 0,7m /</p> <p>6x LEUCHTENDIODEN, KABEL - 0,7m /</p> <p>6x СВЕТОДИОДНЫЙ, КАБЕЛЬ - 0,7м</p>		

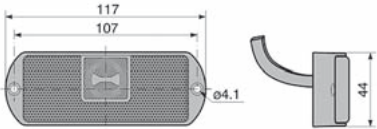
KÓD / ORDER CODE / BESTELL NR. / КОД	POPIS / DESCRIPTION / BESCHREIBUNG / ОПИСАНИЕ	OE / OE NUMBER / OE NUMMER / OE	NÁKRES / DRAWING / ZEICHNUNG / ЧЕРТЁЖ
721376	<p>3x LED, KABEL - 0,7m /</p> <p>3x LEDs, CABLE - 0,7m /</p> <p>3x LEUCHTENDIODEN, KABEL - 0,7m /</p> <p>3x СВЕТОДИОДНЫЙ, КАБЕЛЬ - 0,7м</p>	03.0525.0000.41	
721341	<p>P&R / P&R CLICK / P&R KLICKEN / P&R</p>	25.0054.0000.01	

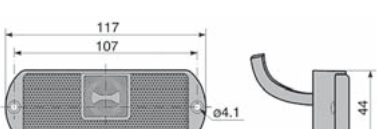
**LED POZIČNÍ SVĚTLA 12V / LED 12V MARKER LAMPS /
LED 12V POSITIONSLEUCHTEN / ДИОДНЫЕ ГАБАРИТНЫЕ ЛАМПЫ 12V**

KÓD / ORDER CODE / BESTELL NR. / КОД		POPIS / DESCRIPTION / BESCHREIBUNG / ОПИСАНИЕ	OE / OE NUMBER / OE NUMMER / OE	NÁKRES / DRAWING / ZEICHNUNG / ЧЕРТЁЖ
721971		6x LED, KABEL - 0,7m / 6x LEDs, CABLE - 0,7m / 6x LEUCHTENDIODEN, KABEL - 0,7m / 6x СВЕТОДИОДНЫЙ, КАБЕЛЬ - 0,7м		

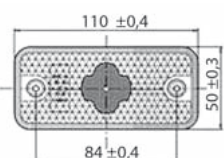
KÓD / ORDER CODE / BESTELL NR. / КОД		POPIS / DESCRIPTION / BESCHREIBUNG / ОПИСАНИЕ	OE / OE NUMBER / OE NUMMER / OE	NÁKRES / DRAWING / ZEICHNUNG / ЧЕРТЁЖ
721349		3x LED, KABEL - 0,7m / 3x LEDs, CABLE - 0,7m / 3x LEUCHTENDIODEN, KABEL - 0,7m / 3x СВЕТОДИОДНЫЙ, КАБЕЛЬ - 0,7м	04.0376.0000.41	
721344		3x LED, KABEL - 0,7m / 3x LEDs, CABLE - 0,7m / 3x LEUCHTENDIODEN, KABEL - 0,7m / 3x СВЕТОДИОДНЫЙ, КАБЕЛЬ - 0,7м	04.0411.0000.41	
721341		P&R / P&R CLICK / P&R KLICKEN / P&R	25.0054.0000.01	

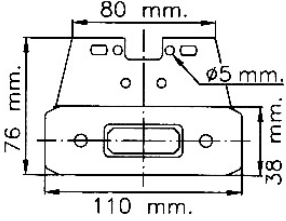

KÓD / ORDER CODE / BESTELL NR. / КОД		POPIS / DESCRIPTION / BESCHREIBUNG / ОПИСАНИЕ	OE / OE NUMBER / OE NUMMER / OE	NÁKRES / DRAWING / ZEICHNUNG / ЧЕРТЁЖ
721307		4x LED, KABEL - 1m / 4x LEDs, CABLE - 1m / 4x LEUCHTENDIODEN, KABEL - 1m / 4x СВЕТОДИОДНЫЙ, КАБЕЛЬ - 1м	A10204	
721468		P&R / P&R CLICK / P&R KLICKEN / P&R	4260089	

LED POZIČNÍ SVĚTLA 12V / LED 12V MARKER LAMPS /
LED 12V POSITIONSLEUCHTEN / ДИОДНЫЕ ГАБАРИТНЫЕ ЛАМПЫ 12V



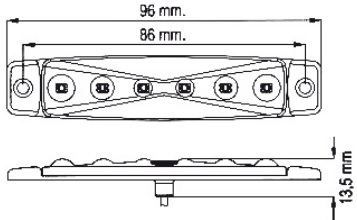

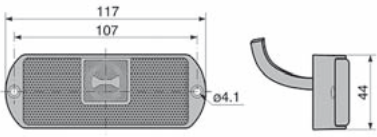

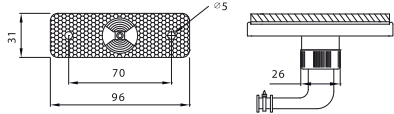

KÓD / ORDER CODE / BESTELL NR. / КОД		POPIS / DESCRIPTION / BESCHREIBUNG / ОПИСАНИЕ	OE / OE NUMBER / OE NUMMER / OE	NÁKRES / DRAWING / ZEICHNUNG / ЧЕРТЁЖ
725752		<p>1x LED / 1x LEDES / 1x LEUCHTENDIODEN / 1x СВЕТОДИОДНЫЙ</p>		

**LED POZIČNÍ SVĚTLA 12V / LED 12V MARKER LAMPS /
LED 12V POSITIONSLEUCHTEN / ДИОДНЫЕ ГАБАРИТНЫЕ ЛАМПЫ 12V**

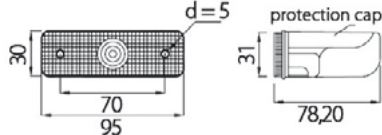
KÓD / ORDER CODE / BESTELL NR. / КОД		POPIS / DESCRIPTION / BESCHREIBUNG / ОПИСАНИЕ	OE / OE NUMBER / OE NUMMER / OE	NÁKRES / DRAWING / ZEICHNUNG / ЧЕРТЁЖ
721973		6x LED, KABEL - 0,7m / 6x LEDs, CABLE - 0,7m / 6x LEUCHTENDIODEN, KABEL - 0,7m / 6x СВЕТОДИОДНЫЙ, КАБЕЛЬ - 0,7м		

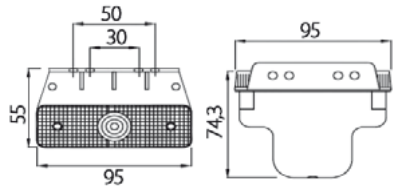



KÓD / ORDER CODE / BESTELL NR. / КОД		POPIS / DESCRIPTION / BESCHREIBUNG / ОПИСАНИЕ	OE / OE NUMBER / OE NUMMER / OE	NÁKRES / DRAWING / ZEICHNUNG / ЧЕРТЁЖ
721384		3x LED, KABEL - 0,7m / 3x LEDs, CABLE - 0,7m / 3x LEUCHTENDIODEN, KABEL - 0,7m / 3x СВЕТОДИОДНЫЙ, КАБЕЛЬ - 0,7м	02.1082.0000.41	
721341		P & R / P & R CLICK / P & R KLICKEN / P & R	25.0054.0000.01	

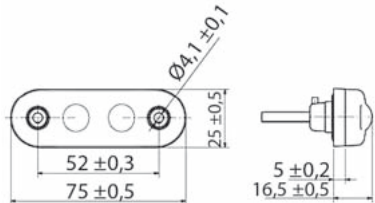

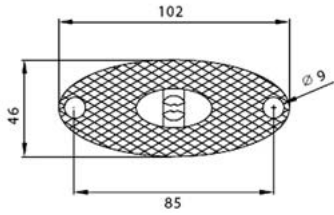

LED 24V POZIČNÍ SVĚTLA / LED 24V MARKER LAMPS LED / LED 24V POSITIONSLEUCHTEN / ДИОДНЫЕ ГАБАРИТНЫЕ ЛАМПЫ 24V

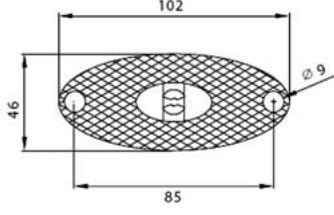
KÓD / ORDER CODE / BESTELL NR. / КОД		POPIS / DESCRIPTION / BESCHREIBUNG / ОПИСАНИЕ	OE / OE NUMBER / OE NUMMER / OE	NÁKRES / DRAWING / ZEICHNUNG / ЧЕРТЁЖ
726953		FLATPOINT KABEL / CABLE / KABEL / КАБЕЛЬ - 0,5m	31-6604-077	
723992		FLATPOINT KABEL / CABLE / KABEL / КАБЕЛЬ - 1,5m	31-6614-037	
726661		FLATPOINT KABEL / CABLE / KABEL / КАБЕЛЬ - 1,5m	31-6614-077	
720477		NÁHRADNÍ KABEL PRO FLATPOINT - 0,5m / CONNECTION CABLE P&R FOR FLATPOINT - 0,5m / ANSCHLUSSKABEL P&R FÜR FLATPOINT - 0,5m / ЗАПАСНОЙ КАБЕЛЬ ДЛЯ FLATPOINT - 0,5m	68-5000-017	
720474		NÁHRADNÍ KABEL PRO FLATPOINT - 1,5m / CONNECTION CABLE P&R FOR FLATPOINT - 1,5m / ANSCHLUSSKABEL P&R FÜR FLATPOINT - 1,5m / ЗАПАСНОЙ КАБЕЛЬ ДЛЯ FLATPOINT - 1,5m	68-5000-037	
721468		P&R / P&R CLICK / P&R KLICKEN / P&R	4260089	

KÓD / ORDER CODE / BESTELL NR. / КОД		POPIS / DESCRIPTION / BESCHREIBUNG / ОПИСАНИЕ	OE / OE NUMBER / OE NUMMER / OE	NÁKRES / DRAWING / ZEICHNUNG / ЧЕРТЁЖ
720470		2x LED, KABEL - 0,5m / 2x LEDs, CABLE - 0,5m / 2x LEUCHTENDIODEN, KABEL - 0,5m / 2x СВЕТОДИОДНЫЙ, КАБЕЛЬ - 0,5m	104290	

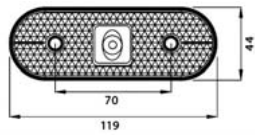
LED 24V POZIČNÍ SVĚTLA / LED 24V MARKER LAMPS LED /
LED 24V POSITIONSLEUCHTEN / ДИОДНЫЕ ГАБАРИТНЫЕ ЛАМПЫ 24V

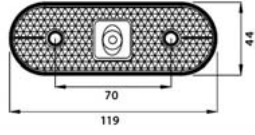
KÓD / ORDER CODE / BESTELL NR. / КОД		POPIS / DESCRIPTION / BESCHREIBUNG / ОПИСАНИЕ	OE / OE NUMBER / OE NUMMER / OE	NÁKRES / DRAWING / ZEICHNUNG / ЧЕРТЁЖ
724018		FLATPOINT II. KABEL / CABLE / КАБЕЛЬ / КАБЕЛЬ - 0,5m	31-6904-017	
724688		FLATPOINT II. KABEL / CABLE / КАБЕЛЬ / КАБЕЛЬ - 1,5m	31-6904-037	
721468		P&R / P&R CLICK / P&R.KLICKEN / P&R	4260089	

KÓD / ORDER CODE / BESTELL NR. / КОД		POPIS / DESCRIPTION / BESCHREIBUNG / ОПИСАНИЕ	OE / OE NUMBER / OE NUMMER / OE	NÁKRES / DRAWING / ZEICHNUNG / ЧЕРТЁЖ
725540		UNIPOINT KABEL / CABLE / КАБЕЛЬ / КАБЕЛЬ - 0,5m	31-7704-017	
725539		UNIPOINT KABEL / CABLE / КАБЕЛЬ / КАБЕЛЬ - 1,5m	31-7704-037	
722529		NÁHRADNÍ KABEL PRO UNIPOINT - 1,5m / CONNECTION CABLE P&R FOR UNIPOINT - 1,5m / ANSCHLUSSKABEL P&R FÜR UNIPOINT - 1,5m / ЗАПАСНОЙ КАБЕЛЬ ДЛЯ UNIPOINT - 1,5m	68-5018-024	
721468		P&R / P&R CLICK / P&R.KLICKEN / P&R	4260089	

LED 24V POZIČNÍ SVĚTLA / LED 24V MARKER LAMPS LED / LED 24V POSITIONSLEUCHTEN / ДИОДНЫЕ ГАБАРИТНЫЕ ЛАМПЫ 24V



KÓD / ORDER CODE / BESTELL NR. / КОД	POPIS / DESCRIPTION / BESCHREIBUNG / ОПИСАНИЕ	OE / OE NUMBER / OE NUMMER / OE	NÁKRES / DRAWING / ZEICHNUNG / ЧЕРТЁЖ
721970	<p>6x LED, KABEL - 0,7 m / 6x LEDs, CABLE - 0,7 m / 6x LEUCHTENDIODEN, KABEL - 0,7 m / 6x СВЕТОДИОДНЫЙ, КАБЕЛЬ - 0,7 м</p>		

KÓD / ORDER CODE / BESTELL NR. / КОД	POPIS / DESCRIPTION / BESCHREIBUNG / ОПИСАНИЕ	OE / OE NUMBER / OE NUMMER / OE	NÁKRES / DRAWING / ZEICHNUNG / ЧЕРТЁЖ
720261	<p>4x LED, KABEL - 0,5 m / 4x LEDs, CABLE - 0,5 m / 4x LEUCHTENDIODEN, KABEL - 0,5 m / 4x СВЕТОДИОДНЫЙ, КАБЕЛЬ - 0,5 м</p>		





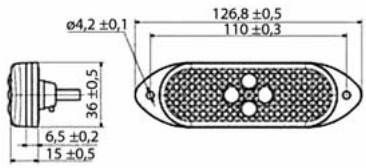



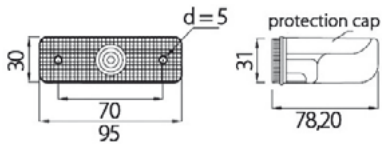

KÓD / ORDER CODE / BESTELL NR. / КОД	POPIS / DESCRIPTION / BESCHREIBUNG / ОПИСАНИЕ	OE / OE NUMBER / OE NUMMER / OE	NÁKRES / DRAWING / ZEICHNUNG / ЧЕРТЁЖ
721383	<p>3x LED, KABEL - 0,7 m / 3x LEDs, CABLE - 0,7 m / 3x LEUCHTENDIODEN, KABEL - 0,7 m / 3x СВЕТОДИОДНЫЙ, КАБЕЛЬ - 0,7 м</p>	03.0526.0000.42	
721341	<p>P&R / P&R CLICK / P&R KLICKEN / P&R</p>	25.0054.0000.01	

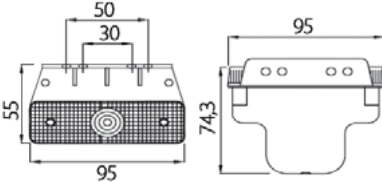
KÓD / ORDER CODE / BESTELL NR. / КОД	POPIS / DESCRIPTION / BESCHREIBUNG / ОПИСАНИЕ	OE / OE NUMBER / OE NUMMER / OE	NÁKRES / DRAWING / ZEICHNUNG / ЧЕРТЁЖ
721306	<p>4x LED, KABEL - 1 m / 4x LEDs, CABLE - 1 m / 4x LEUCHTENDIODEN, KABEL - 1 m / 4x СВЕТОДИОДНЫЙ, КАБЕЛЬ - 1 м</p>	D10500	
721468	<p>P&R / P&R CLICK / P&R KLICKEN / P&R</p>	4260089	

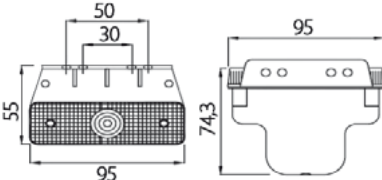

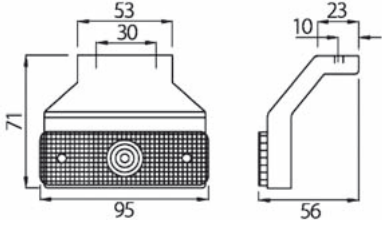
**LED 24V POZIČNÍ SVĚTLA / LED 24V MARKER LAMPS LED /
LED 24V POSITIONSLEUCHTEN / ДИОДНЫЕ ГАБАРИТНЫЕ ЛАМПЫ 24V**







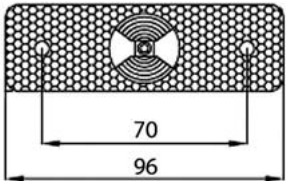

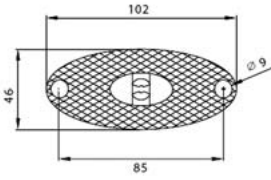

KÓD / ORDER CODE / BESTELL NR. / КОД		POPIS / DESCRIPTION / BESCHREIBUNG / ОПИСАНИЕ	OE / OE NUMBER / OE NUMMER / OE	NÁKRES / DRAWING / ZEICHNUNG / ЧЕРТЕЖ		
721304		4x LED, KABEL - 0,5m / 4x LEDs, CABLE - 0,5m / 4x LEUCHTENDIODEN, KABEL - 0,5m / 4x СВЕТОДИОДНЫЙ, КАБЕЛЬ - 0,5м	104130			
721468		P&R / P&R CLICK / P&R.KLICKEN / P&R	4260089			

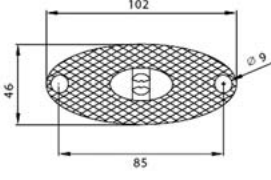
LED 24V POZIČNÍ SVĚTLA / LED 24V MARKER LAMPS LED /
LED 24V POSITIONSLEUCHTEN / ДИОДНЫЕ ГАБАРИТНЫЕ ЛАМПЫ 24V

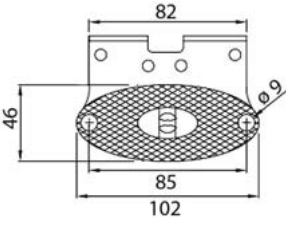

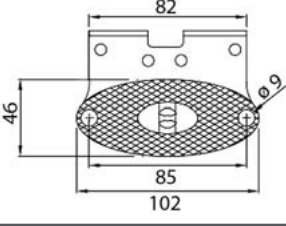

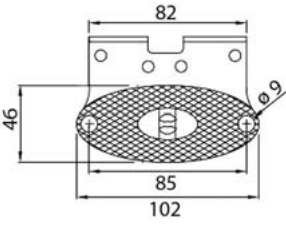



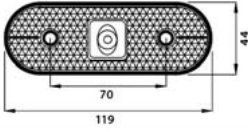

KÓD / ORDER CODE / BESTELL NR. / КОД		POPIS / DESCRIPTION / BESCHREIBUNG / ОПИСАНИЕ	OE / OE NUMBER / OE NUMMER / OE	NÁKRES / DRAWING / ZEICHNUNG / ЧЕРТЁЖ
724044		FLATPOINT KABEL / CABLE / KABEL / КАБЕЛЬ - 0,5m	31-2214-117	
726956		FLATPOINT KABEL / CABLE / KABEL / КАБЕЛЬ - 0,5m	31-2214-017	
726965		FLATPOINT KABEL / CABLE / KABEL / КАБЕЛЬ - 1,5m	31-2214-037	
724045		FLATPOINT KABEL / CABLE / KABEL / КАБЕЛЬ - 0,5m	31-2264-017	
720477		KABEL / CABLE / KABEL / КАБЕЛЬ - 0,5m	68-5000-017	
720474		KABEL / CABLE / KABEL / КАБЕЛЬ - 1,5m	68-5000-037	
721468		P&R / P&R CLICK / P&R KLICKEN / P&R	4260089	

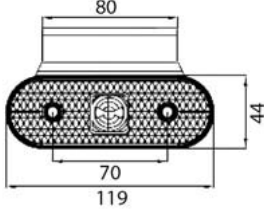
**LED 24V POZIČNÍ SVĚTLA / LED 24V MARKER LAMPS LED /
LED 24V POSITIONSLEUCHTEN / ДИОДНЫЕ ГАБАРИТНЫЕ ЛАМПЫ 24V**

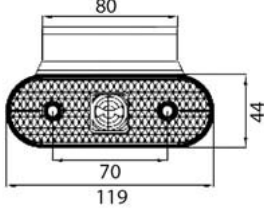

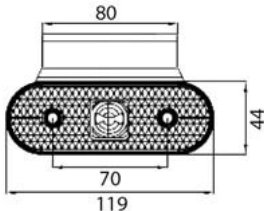
KÓD / ORDER CODE / BESTELL NR. / КОД		POPIS / DESCRIPTION / BESCHREIBUNG / ОПИСАНИЕ	OE / OE NUMBER / OE NUMMER / OE	NÁKRES / DRAWING / ZEICHNUNG / ЧЕРТЁЖ
725145		FLATPOINT BEZ KABELU / WITHOUT CABLE / OHNE KABEL / БЕЗ ПРОВОДА	21-2200-004	
725165		OPRAVNÁ SADA / REPAIR KIT / ANSCHLUSSSATZ / РЕМОНТНЫЙ КОМПЛЕКТ	15-2122-104	

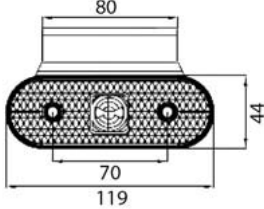

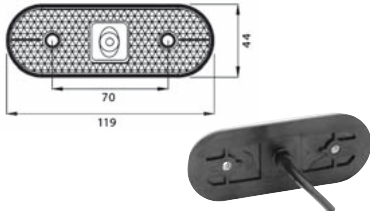

KÓD / ORDER CODE / BESTELL NR. / КОД		POPIS / DESCRIPTION / BESCHREIBUNG / ОПИСАНИЕ	OE / OE NUMBER / OE NUMMER / OE	NÁKRES / DRAWING / ZEICHNUNG / ЧЕРТЁЖ
726992		FLATPOINT II. KABEL / CABLE / KABEL / КАБЕЛЬ - 0,5 m	31-2304-017	
726996		FLATPOINT II. KABEL / CABLE / KABEL / КАБЕЛЬ - 1,5 m	31-2304-037	
726659		FLATPOINT II. KABEL / CABLE / KABEL / КАБЕЛЬ - 0,5 m	31-2364-087	
726664		FLATPOINT II. KABEL / CABLE / KABEL / КАБЕЛЬ - 1,5 m	31-2364-107	
724049		FLATPOINT II. KABEL / CABLE / KABEL / КАБЕЛЬ - 0,5 m	31-2364-017	
721468		P&R / P&R CLICK / P&R KLICKEN / P&R	4260089	

LED 24V POZIČNÍ SVĚTLA / LED 24V MARKER LAMPS LED /
LED 24V POSITIONSLEUCHTEN / ДИОДНЫЕ ГАБАРИТНЫЕ ЛАМПЫ 24V

KÓD / ORDER CODE / BESTELL NR. / КОД		POPIS / DESCRIPTION / BESCHREIBUNG / ОПИСАНИЕ	OE / OE NUMBER / OE NUMMER / OE	NÁKRES / DRAWING / ZEICHNUNG / ЧЕРТЁЖ
724051		UNIPOINT KABEL / CABLE / KABEL / КАБЕЛЬ - 0,5m	31-2004-017	
726955		UNIPOINT KABEL / CABLE / KABEL / КАБЕЛЬ - 0,5m	31-2064-017	
726963		UNIPOINT KABEL / CABLE / KABEL / КАБЕЛЬ - 1,5m	31-2064-037	
724052		UNIPOINT KABEL / CABLE / KABEL / КАБЕЛЬ - 0,5m	31-2064-717	
724120		UNIPOINT KABEL / CABLE / KABEL / КАБЕЛЬ - 0,5m	31-2064-217	
722529		NÁHRADNÍ KABEL PRO UNIPOINT - 1,5m / CONNECTION CABLE P&R FOR UNIPOINT - 1,5m / ANSCHLUSSKABEL P&R FÜR UNIPOINT - 1,5m / ЗАПАСНОЙ КАБЕЛЬ ДЛЯ UNIPOINT - 1,5м	68-5018-024	
721468		P&R / P&R CLICK / P&R KLICKEN / P&R	4260089	

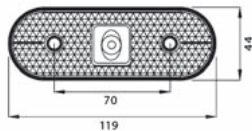

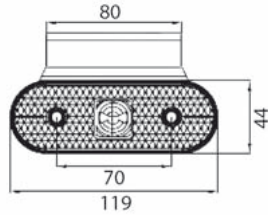



**LED 24V POZIČNÍ SVĚTLA / LED 24V MARKER LAMPS LED /
LED 24V POSITIONSLEUCHTEN / ДИОДНЫЕ ГАБАРИТНЫЕ ЛАМПЫ 24V**

KÓD / ORDER CODE / BESTELL NR. / КОД		POPIS / DESCRIPTION / BESCHREIBUNG / ОПИСАНИЕ	OE / OE NUMBER / OE NUMMER / OE	NÁKRES / DRAWING / ZEICHNUNG / ЧЕРТЁЖ
724050		UNIPOINT	31-2104-017	
721468		P&R / P&R CLICK / P&R KLICKEN / P&R	4260089	

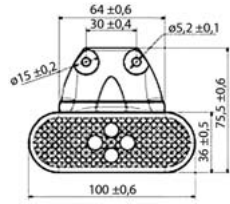
KÓD / ORDER CODE / BESTELL NR. / КОД		POPIS / DESCRIPTION / BESCHREIBUNG / ОПИСАНИЕ	OE / OE NUMBER / OE NUMMER / OE	NÁKRES / DRAWING / ZEICHNUNG / ЧЕРТЁЖ
726978		UNIPOINT BEZ KABELU / WITHOUT CABLE / OHNE KABEL / БЕЗ ПРОВОДА	21-2000-004	
726962		UNIPOINT BEZ KABELU / WITHOUT CABLE / OHNE KABEL / БЕЗ ПРОВОДА	21-2000-045	
722525		OPRAVNÁ SADA / REPAIR KIT / ANSCHLUSSSATZ / РЕМОНТНЫЙ КОМПЛЕКТ	15-5624-024	

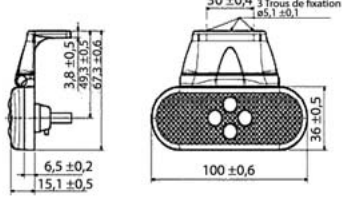

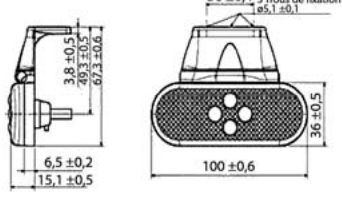



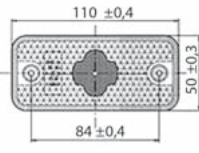

KÓD / ORDER CODE / BESTELL NR. / КОД		POPIS / DESCRIPTION / BESCHREIBUNG / ОПИСАНИЕ	OE / OE NUMBER / OE NUMMER / OE	NÁKRES / DRAWING / ZEICHNUNG / ЧЕРТЁЖ
721352		3x LED, KABEL - 0,7m / 3x LEADS, CABLE - 0,7m / 3x LEUCHTENDIODEN, KABEL - 0,7m / 3x СВЕТОДИОДНЫЙ, КАБЕЛЬ - 0,7м	04.0377.0000.42	
721345		3x LED, KABEL - 0,7m / 3x LEADS, CABLE - 0,7m / 3x LEUCHTENDIODEN, KABEL - 0,7m / 3x СВЕТОДИОДНЫЙ, КАБЕЛЬ - 0,7м	04.0412.0000.42	
721341		P&R / P&R CLICK / P&R KLICKEN / P&R	25.0054.0000.01	

LED 24V POZIČNÍ SVĚTLA / LED 24V MARKER LAMPS LED /
LED 24V POSITIONSLEUCHTEN / ДИОДНЫЕ ГАБАРИТНЫЕ ЛАМПЫ 24V

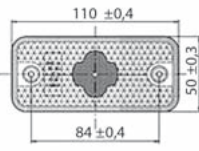
KÓD / ORDER CODE / BESTELL NR. / КОД		POPIS / DESCRIPTION / BESCHREIBUNG / ОПИСАНИЕ	OE / OE NUMBER / OE NUMMER / OE	NÁKRES / DRAWING / ZEICHNUNG / ЧЕРТЁЖ
721313		4x LED, KABEL - 0,5m / 4x LEDs, CABLE - 0,5m / 4x LEUCHTENDIODEN, KABEL - 0,5m / 4x СВЕТОДИОДНЫЙ, КАБЕЛЬ - 0,5м	104210	
721314		4x LED, KABEL - 0,5m / 4x LEDs, CABLE - 0,5m / 4x LEUCHTENDIODEN, KABEL - 0,5m / 4x СВЕТОДИОДНЫЙ, КАБЕЛЬ - 0,5м	104250	
720460		4x LED, KABEL - 1,5m / 4x LEDs, CABLE - 1,5m / 4x LEUCHTENDIODEN, KABEL - 1,5m / 4x СВЕТОДИОДНЫЙ, КАБЕЛЬ - 1,5м	104260	
721468		P&R / P&R CLICK / P&R KLICKEN / P&R	4260089	

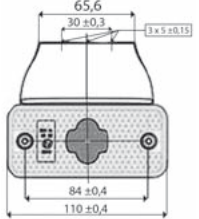
KÓD / ORDER CODE / BESTELL NR. / КОД		POPIS / DESCRIPTION / BESCHREIBUNG / ОПИСАНИЕ	OE / OE NUMBER / OE NUMMER / OE	NÁKRES / DRAWING / ZEICHNUNG / ЧЕРТЁЖ
721565		4x LED, BEZ KABELU / 4x LEDs, WITHOUT CABLE / 4x LEUCHTENDIODEN, OHNE KABEL / 4x СВЕТОДИОДНЫЙ, БЕЗ ПРОВОДА	198520	
721566		2x LED, BEZ KABELU / 2x LEDs, WITHOUT CABLE / 2x LEUCHTENDIODEN, OHNE KABEL / 2x СВЕТОДИОДНЫЙ, БЕЗ ПРОВОДА	198540	
720006		OPRAVNÁ SADA / REPAIR KIT / ANSCHLUSSSATZ / РЕМОНТНЫЙ КОМПЛЕКТ		

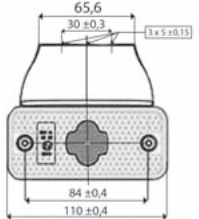
**LED 24V POZIČNÍ SVĚTLA / LED 24V MARKER LAMPS LED /
LED 24V POSITIONSLEUCHTEN / ДИОДНЫЕ ГАБАРИТНЫЕ ЛАМПЫ 24V**

KÓD / ORDER CODE / BESTELL NR. / КОД		POPIS / DESCRIPTION / BESCHREIBUNG / ОПИСАНИЕ	OE / OE NUMBER / OE NUMMER / OE	NÁKRES / DRAWING / ZEICHNUNG / ЧЕРТЁЖ
721315		4x LED, KABEL - 0,5m / 4x LEDs, CABLE - 0,5m / 4x LEUCHTENDIODEN, KABEL - 0,5m / 4x СВЕТОДИОДНЫЙ, КАБЕЛЬ - 0,5м	D10493	
721316		4x LED, KABEL - 1,5m / 4x LEDs, CABLE - 1,5m / 4x LEUCHTENDIODEN, KABEL - 1,5m / 4x СВЕТОДИОДНЫЙ, КАБЕЛЬ - 1,5м	D10496	
721324		2x LED, KABEL - 1m / 2x LEDs, CABLE - 1m / 2x LEUCHTENDIODEN, KABEL - 1m / 2x СВЕТОДИОДНЫЙ, КАБЕЛЬ - 1м		
721319		2x LED, KABEL - 1,5m / 2x LEDs, CABLE - 1,5m / 2x LEUCHTENDIODEN, KABEL - 1,5m / 2x СВЕТОДИОДНЫЙ, КАБЕЛЬ - 1,5м	D10497	
721468		P&R / P&R CLICK / P&R KLICKEN / P&R	4260089	

KÓD / ORDER CODE / BESTELL NR. / КОД		POPIS / DESCRIPTION / BESCHREIBUNG / ОПИСАНИЕ	OE / OE NUMBER / OE NUMMER / OE	NÁKRES / DRAWING / ZEICHNUNG / ЧЕРТЁЖ
720458		4x LED, KABEL - 1,5m / 4x LEDs, CABLE - 1,5m / 4x LEUCHTENDIODEN, KABEL - 1,5m / 4x СВЕТОДИОДНЫЙ, КАБЕЛЬ - 1,5м	104100	
721468		P&R / P&R CLICK / P&R KLICKEN / P&R	4260089	

LED 24V POZIČNÍ SVĚTLA / LED 24V MARKER LAMPS LED / LED 24V POSITIONSLEUCHTEN / ДИОДНЫЕ ГАБАРИТНЫЕ ЛАМПЫ 24V

KÓD / ORDER CODE / BESTELL NR. / КОД	POPIS / DESCRIPTION / BESCHREIBUNG / ОПИСАНИЕ	OE / OE NUMBER / OE NUMMER / OE	NÁKRES / DRAWING / ZEICHNUNG / ЧЕРТЁЖ
722181	<p>3x LED, KABEL - 0,3m / 3x LEDs, CABLE - 0,3m / 3x LEUCHTENDIODEN, KABEL - 0,3m / 3x СВЕТОДИОДНЫЙ, КАБЕЛЬ - 0,3м</p>	2PS963639-011	
722180	<p>3x LED, KABEL - 0,3m / 3x LEDs, CABLE - 0,3m / 3x LEUCHTENDIODEN, KABEL - 0,3m / 3x СВЕТОДИОДНЫЙ, КАБЕЛЬ - 0,3м</p>	2PS340001-001	



KÓD / ORDER CODE / BESTELL NR. / КОД	POPIS / DESCRIPTION / BESCHREIBUNG / ОПИСАНИЕ	OE / OE NUMBER / OE NUMMER / OE	NÁKRES / DRAWING / ZEICHNUNG / ЧЕРТЁЖ
725749	<p>1x LED / 1x LEDs / 1x LEUCHTENDIODEN / 1x СВЕТОДИОДНЫЙ</p>		



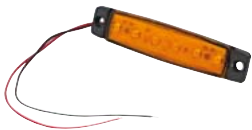
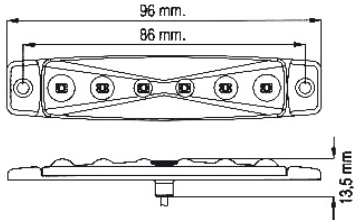

KÓD / ORDER CODE / BESTELL NR. / КОД	POPIS / DESCRIPTION / BESCHREIBUNG / ОПИСАНИЕ	OE / OE NUMBER / OE NUMMER / OE	NÁKRES / DRAWING / ZEICHNUNG / ЧЕРТЁЖ
722764	<p>4x LED, KABEL - 0,5m / 4x LEDs, CABLE - 0,5m / 4x LEUCHTENDIODEN, KABEL - 0,5m / 4x СВЕТОДИОДНЫЙ, КАБЕЛЬ - 0,5м</p>		
721468	<p>P&R / P&R CLICK / P&R KLICKEN / P&R</p>	4260089	

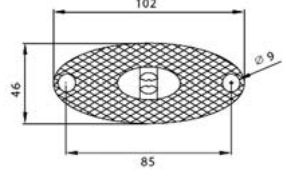
**LED 24V POZIČNÍ SVĚTLA / LED 24V MARKER LAMPS LED /
LED 24V POSITIONSLEUCHTEN / ДИОДНЫЕ ГАБАРИТНЫЕ ЛАМПЫ 24V**

KÓD / ORDER CODE / BESTELL NR. / КОД		POPIS / DESCRIPTION / BESCHREIBUNG / ОПИСАНИЕ	OE / OE NUMBER / OE NUMMER / OE	NÁKRES / DRAWING / ZEICHNUNG / ЧЕРТЁЖ
721972		<p>6x LED, KABEL - 0,7m / 6x LEDs, CABLE - 0,7m / 6x LEUCHTENDIODEN, KABEL - 0,7m / 6x СВЕТОДИОДНЫЙ, КАБЕЛЬ - 0,7м</p>		

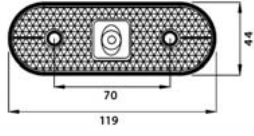

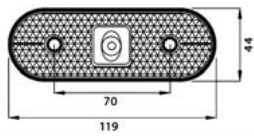
LED 24V POZIČNÍ SVĚTLA / LED 24V MARKER LAMPS LED /
LED 24V POSITIONSLEUCHTEN / ДИОДНЫЕ ГАБАРИТНЫЕ ЛАМПЫ 24V

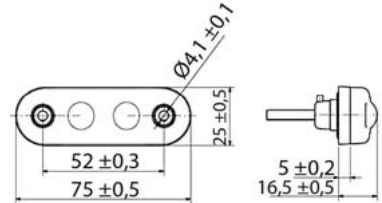

KÓD / ORDER CODE / BESTELL NR. / КОД		POPIS / DESCRIPTION / BESCHREIBUNG / ОПИСАНИЕ	OE / OE NUMBER / OE NUMMER / OE	NÁKRES / DRAWING / ZEICHNUNG / ЧЕРТЁЖ
724019		FLATPOINT II. KABEL / CABLE / KABEL / КАБЕЛЬ - 0,5m	31-6404-017	
721468		P&R / P&R CLICK / P&R KLICKEN / P&R	4260089	

KÓD / ORDER CODE / BESTELL NR. / КОД		POPIS / DESCRIPTION / BESCHREIBUNG / ОПИСАНИЕ	OE / OE NUMBER / OE NUMMER / OE	NÁKRES / DRAWING / ZEICHNUNG / ЧЕРТЁЖ
723969		UNIPOINT KABEL / CABLE / KABEL / КАБЕЛЬ - 0,5m	31-7804-017	
723970		UNIPOINT KABEL / CABLE / KABEL / КАБЕЛЬ - 3,5m	31-7804-057	
722529		NÁHRADNÍ KABEL PRO UNIPOINT - 1,5m / CONNECTION CABLE P&R FOR UNIPOINT - 1,5m / ANSCHLUSSKABEL P&R FÜR UNIPOINT - 1,5m / ЗАПАСНОЙ КАБЕЛЬ ДЛЯ UNIPOINT - 1,5m	68-5018-024	
721468		P&R / P&R CLICK / P&R KLICKEN / P&R	4260089	

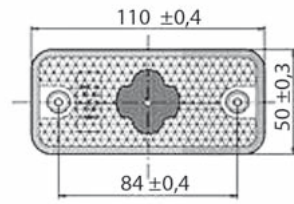
KÓD / ORDER CODE / BESTELL NR. / КОД		POPIS / DESCRIPTION / BESCHREIBUNG / ОПИСАНИЕ	OE / OE NUMBER / OE NUMMER / OE	NÁKRES / DRAWING / ZEICHNUNG / ЧЕРТЁЖ
721360		2x LED, KABEL - 0,5m / 2x LEDs, CABLE - 0,5m / 2x LEUCHTENDIODEN, KABEL - 0,5m / 2x СВЕТОДИОДНЫЙ, КАБЕЛЬ - 0,5m	104330	

**LED 24V POZIČNÍ SVĚTLA / LED 24V MARKER LAMPS LED /
LED 24V POSITIONSLEUCHTEN / ДИОДНЫЕ ГАБАРИТНЫЕ ЛАМПЫ 24V**

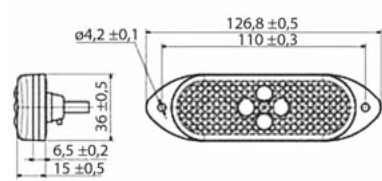

KÓD / ORDER CODE / BESTELL NR. / КОД		POPIS / DESCRIPTION / BESCHREIBUNG / ОПИСАНИЕ	OE / OE NUMBER / OE NUMMER / OE	NÁKRES / DRAWING / ZEICHNUNG / ЧЕРТЁЖ
721362		4x LED, KABEL - 1,5 m / 4x LEDES, CABLE - 1,5 m / 4x LEUCHTENDIODEN, KABEL - 1,5 m / 4x СВЕТОДИОДНЫЙ, КАБЕЛЬ - 1,5 м	D11400	
721468		P&R / P&R CLICK / P&R KLICKEN / P&R	4260089	

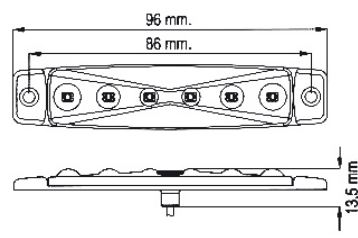
KÓD / ORDER CODE / BESTELL NR. / КОД		POPIS / DESCRIPTION / BESCHREIBUNG / ОПИСАНИЕ	OE / OE NUMBER / OE NUMMER / OE	NÁKRES / DRAWING / ZEICHNUNG / ЧЕРТЁЖ
721361		4x LED, KABEL - 0,5 m / 4x LEDES, CABLE - 0,5 m / 4x LEUCHTENDIODEN, KABEL - 0,5 m / 4x СВЕТОДИОДНЫЙ, КАБЕЛЬ - 0,5 м	104170	
721468		P&R / P&R CLICK / P&R KLICKEN / P&R	4260089	

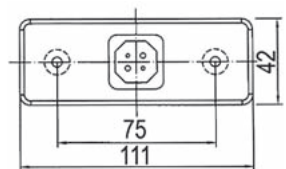



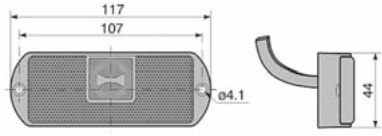





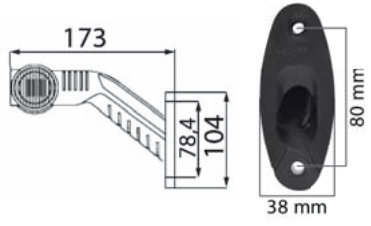

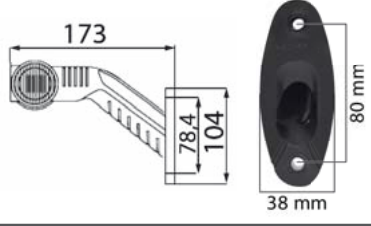
KÓD / ORDER CODE / BESTELL NR. / КОД		POPIS / DESCRIPTION / BESCHREIBUNG / ОПИСАНИЕ	OE / OE NUMBER / OE NUMMER / OE	NÁKRES / DRAWING / ZEICHNUNG / ЧЕРТЁЖ
721974		6x LED, KABEL - 0,7 m / 6x LEDES, CABLE - 0,7 m / 6x LEUCHTENDIODEN, KABEL - 0,7 m / 6x СВЕТОДИОДНЫЙ, КАБЕЛЬ - 0,7 м		

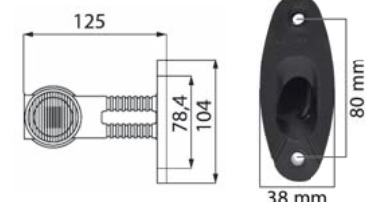
KÓD / ORDER CODE / BESTELL NR. / КОД		POPIS / DESCRIPTION / BESCHREIBUNG / ОПИСАНИЕ	OE / OE NUMBER / OE NUMMER / OE	NÁKRES / DRAWING / ZEICHNUNG / ЧЕРТЁЖ
726550		4x LED, KABEL - 0,5 m / 4x LEDES, CABLE - 0,5 m / 4x LEUCHTENDIODEN, KABEL - 0,5 m / 4x СВЕТОДИОДНЫЙ, КАБЕЛЬ - 0,5 м		

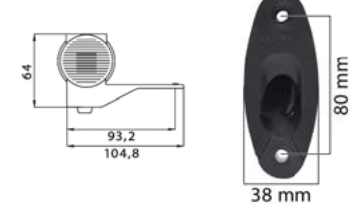

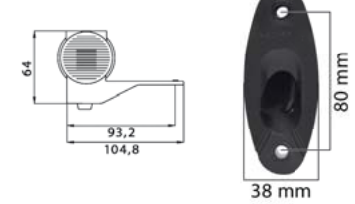

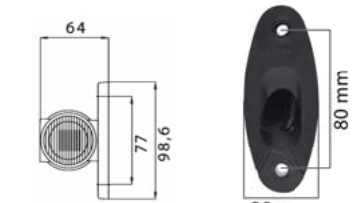





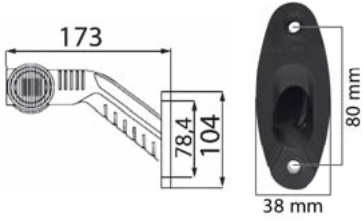

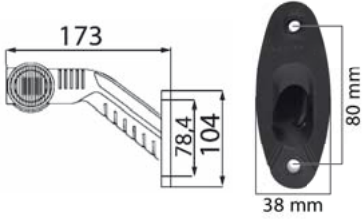
LED 24V POZIČNÍ SVĚTLA / LED 24V MARKER LAMPS LED /
LED 24V POSITIONSLEUCHTEN / ДИОДНЫЕ ГАБАРИТНЫЕ ЛАМПЫ 24V

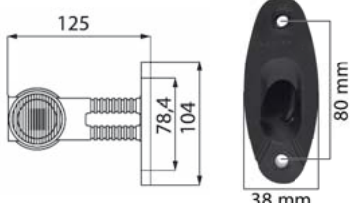
KÓD / ORDER CODE / BESTELL NR. / КОД		POPIS / DESCRIPTION / BESCHREIBUNG / ОПИСАНИЕ	OE / OE NUMBER / OE NUMMER / OE	NÁKRES / DRAWING / ZEICHNUNG / ЧЕРТЁЖ
721395		3x LED, KABEL - 0,7m / 3x LEDs, CABLE - 0,7m / 3x LEUCHTENDIODEN, KABEL - 0,7m / 3x СВЕТОДИОДНЫЙ, КАБЕЛЬ - 0,7м	02.1083.0000.42	
721341		P&R / P&R CLICK / P&R KLICKEN / P&R	25.0054.0000.01	

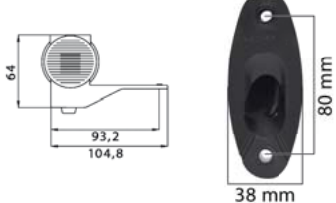

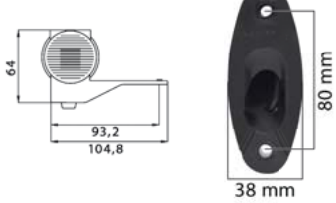

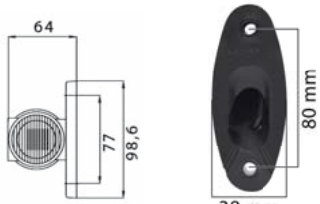
**LED 24V OBRYSOVÁ SVĚTLA / LED 24V OUTLINE MARKER LAMPS /
LED 24V UMRISSELEUCHTEN / ДИОДНЫЕ КОНТУРНЫЕ ЛАМПЫ 24V**



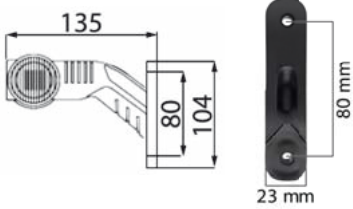

KÓD / ORDER CODE / BESTELL NR. / КОД		POPIS / DESCRIPTION / BESCHREIBUNG / ОПИСАНИЕ	OE / OE NUMBER / OE NUMMER / OE	NÁKRES / DRAWING / ZEICHNUNG / ЧЕРТЁЖ
<p>724112 PRAVÁ / RIGHT / RECHTS / ПРАВЯЯ</p>		<p>SUPERPOINT III. ČERVENÁ + BÍLÁ + ORANŽOVÁ, KABEL - 1,25m / RED + WHITE + ORANGE, CABLE - 1,25m / ROT + WEISS + ORANGE, KABEL - 1,25m / КРАСНАЯ + БЕЛАЯ + ОРАНЖЕВАЯ, КАБЕЛЬ - 1,25м</p>	<p>31-3304-057</p>	
<p>724114 LEVÁ / LEFT / LINKS / ЛЕВАЯ</p>		<p>SUPERPOINT III. ČERVENÁ + BÍLÁ + ORANŽOVÁ, KABEL - 1,25m / RED + WHITE + ORANGE, CABLE - 1,25m / ROT + WEISS + ORANGE, KABEL - 1,25m / КРАСНАЯ + БЕЛАЯ + ОРАНЖЕВАЯ, КАБЕЛЬ - 1,25м</p>	<p>31-3304-047</p>	
		<p>SUPERPOINT III. ČERVENÁ + BÍLÁ + ORANŽOVÁ, KABEL - 1,25m / RED + WHITE + ORANGE, CABLE - 1,25m / ROT + WEISS + ORANGE, KABEL - 1,25m / КРАСНАЯ + БЕЛАЯ + ОРАНЖЕВАЯ, КАБЕЛЬ - 1,25м</p>	<p>31-3304-097</p>	
<p>724155 PRAVÁ / RIGHT / RECHTS / ПРАВЯЯ</p>		<p>SUPERPOINT III. ČERVENÁ + BÍLÁ + ORANŽOVÁ, KABEL - 1,25m / RED + WHITE + ORANGE, CABLE - 1,25m / ROT + WEISS + ORANGE, KABEL - 1,25m / КРАСНАЯ + БЕЛАЯ + ОРАНЖЕВАЯ, КАБЕЛЬ - 1,25м</p>	<p>31-3364-027</p>	
<p>724162 LEVÁ / LEFT / LINKS / ЛЕВАЯ</p>		<p>SUPERPOINT III. ČERVENÁ + BÍLÁ + ORANŽOVÁ, KABEL - 1,25m / RED + WHITE + ORANGE, CABLE - 1,25m / ROT + WEISS + ORANGE, KABEL - 1,25m / КРАСНАЯ + БЕЛАЯ + ОРАНЖЕВАЯ, КАБЕЛЬ - 1,25м</p>	<p>31-3364-057</p>	
<p>724131</p>		<p>SUPERPOINT III. ČERVENÁ + BÍLÁ + ORANŽOVÁ, KABEL - 1,25m / RED + WHITE + ORANGE, CABLE - 1,25m / ROT + WEISS + ORANGE, KABEL - 1,25m / КРАСНАЯ + БЕЛАЯ + ОРАНЖЕВАЯ, КАБЕЛЬ - 1,25м</p>	<p>31-3364-007</p>	
<p>724123</p>		<p>SUPERPOINT III. ČERVENÁ + BÍLÁ + ORANŽOVÁ, KABEL - 1,25m / RED + WHITE + ORANGE, CABLE - 1,25m / ROT + WEISS + ORANGE, KABEL - 1,25m / КРАСНАЯ + БЕЛАЯ + ОРАНЖЕВАЯ, КАБЕЛЬ - 1,25м</p>	<p>21-3351-707</p>	
<p>721468</p>		<p>P & R / P&R CLICK / P & R KLICKEN / P&R</p>	<p>4260089</p>	

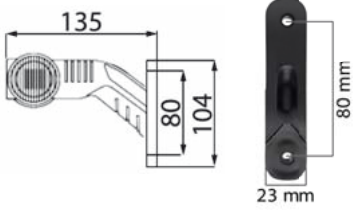
**LED 24V OBRYSOVÁ SVĚTLA / LED 24V OUTLINE MARKER LAMPS /
LED 24V UMRISSELEUCHTEN / ДИОДНЫЕ КОНТУРНЫЕ ЛАМПЫ 24V**

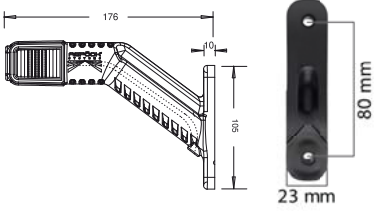

KÓD / ORDER CODE / BESTELL NR. / КОД		POPIS / DESCRIPTION / BESCHREIBUNG / ОПИСАНИЕ	OE / OE NUMBER / OE NUMMER / OE	NÁKRES / DRAWING / ZEICHNUNG / ЧЕРТЕЖ
<p>724126 PRAVÁ / RIGHT / RECHTS / ПРАВАЯ</p>		<p>SUPERPOINT III. ČERNÁ + BÍLÁ + ORANŽOVÁ, KABEL - 1,25 m / BLACK + CLEAR + ORANGE, CABLE - 1,25 m / SCHWARZ + WEISS + ORANGE, KABEL - 1,25 m / ЧЕРНАЯ + БЕЛАЯ + ОРАНЖЕВАЯ, ПРОВОД - 1,25 м</p>	<p>31-3304-077</p>	
<p>724127 LEVÁ / LEFT / LINKS / ЛЕВАЯ</p>		<p>SUPERPOINT III. ČERNÁ + BÍLÁ + ORANŽOVÁ, KABEL - 1,25 m / BLACK + CLEAR + ORANGE, CABLE - 1,25 m / SCHWARZ + WEISS + ORANGE, KABEL - 1,25 m / ЧЕРНАЯ + БЕЛАЯ + ОРАНЖЕВАЯ, ПРОВОД - 1,25 м</p>	<p>31-3304-067</p>	
<p>724168</p>		<p>SUPERPOINT III. ČERNÁ + BÍLÁ + ORANŽOVÁ, KABEL - 1,25 m / BLACK + CLEAR + ORANGE, CABLE - 1,25 m / SCHWARZ + WEISS + ORANGE, KABEL - 1,25 m / ЧЕРНАЯ + БЕЛАЯ + ОРАНЖЕВАЯ, ПРОВОД - 1,25 м</p>	<p>31-3304-087</p>	
<p>724130 PRAVÁ / RIGHT / RECHTS / ПРАВАЯ</p>		<p>SUPERPOINT III. ČERNÁ + BÍLÁ + ORANŽOVÁ, KABEL - 1,25 m / BLACK + CLEAR + ORANGE, CABLE - 1,25 m / SCHWARZ + WEISS + ORANGE, KABEL - 1,25 m / ЧЕРНАЯ + БЕЛАЯ + ОРАНЖЕВАЯ, ПРОВОД - 1,25 м</p>	<p>31-3364-037</p>	
<p>724139 LEVÁ / LEFT / LINKS / ЛЕВАЯ</p>		<p>SUPERPOINT III. ČERNÁ + BÍLÁ + ORANŽOVÁ, KABEL - 1,25 m / BLACK + CLEAR + ORANGE, CABLE - 1,25 m / SCHWARZ + WEISS + ORANGE, KABEL - 1,25 m / ЧЕРНАЯ + БЕЛАЯ + ОРАНЖЕВАЯ, ПРОВОД - 1,25 м</p>	<p>31-3364-047</p>	
<p>724137</p>		<p>SUPERPOINT III. ČERNÁ + BÍLÁ + ORANŽOVÁ, KABEL - 1,25 m / BLACK + CLEAR + ORANGE, CABLE - 1,25 m / SCHWARZ + WEISS + ORANGE, KABEL - 1,25 m / ЧЕРНАЯ + БЕЛАЯ + ОРАНЖЕВАЯ, ПРОВОД - 1,25 м</p>	<p>31-3364-017</p>	
<p>721468</p>		<p>P&R / P&R CLICK / P&R KLICKEN / P&R</p>	<p>4260089</p>	

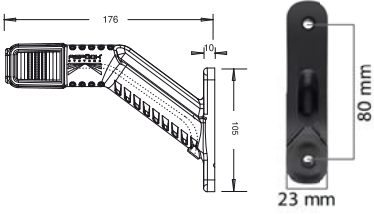
**LED 24V OBRYSOVÁ SVĚTLA / LED 24V OUTLINE MARKER LAMPS /
LED 24V UMRISSELEUCHTEN / ДИОДНЫЕ КОНТУРНЫЕ ЛАМПЫ 24V**

KÓD / ORDER CODE / BESTELL NR. / КОД		POPIS / DESCRIPTION / BESCHREIBUNG / ОПИСАНИЕ	OE / OE NUMBER / OE NUMMER / OE	NÁKRES / DRAWING / ZEICHNUNG / ЧЕРТЁЖ
724147 PRAVÁ / RIGHT / RECHTS / ПРАВАЯ		SUPERPOINT III. ČERVENÁ + BILÁ + ORANŽOVÁ, KABEL - 1,25m / RED + WHITE + ORANGE, CABLE - 1,25m / ROT + WEISS + ORANGE, KABEL - 1,25m / КРАСНАЯ + БЕЛАЯ + ОРАНЖЕВАЯ, КАБЕЛЬ - 1,25м	31-3306-237	
724148 LEVÁ / LEFT / LINKS / ЛЕВАЯ		SUPERPOINT III. ČERVENÁ + BILÁ + ORANŽOVÁ, KABEL - 1,25m / RED + WHITE + ORANGE, CABLE - 1,25m / ROT + WEISS + ORANGE, KABEL - 1,25m / КРАСНАЯ + БЕЛАЯ + ОРАНЖЕВАЯ, КАБЕЛЬ - 1,25м	31-3305-237	
724123		SUPERPOINT III. ČERVENÁ + BILÁ + ORANŽOVÁ, KABEL - 1,25m / RED + WHITE + ORANGE, CABLE - 1,25m / ROT + WEISS + ORANGE, KABEL - 1,25m / КРАСНАЯ + БЕЛАЯ + ОРАНЖЕВАЯ, КАБЕЛЬ - 1,25м	21-3351-707	
721468		P&R / P&R CLICK / P&R KLICKEN / P&R	4260089	

KÓD / ORDER CODE / BESTELL NR. / КОД		POPIS / DESCRIPTION / BESCHREIBUNG / ОПИСАНИЕ	OE / OE NUMBER / OE NUMMER / OE	NÁKRES / DRAWING / ZEICHNUNG / ЧЕРТЁЖ
724203 PRAVÁ / RIGHT / RECHTS / ПРАВАЯ		SUPERPOINT IV. ČERVENÁ + BILÁ + ORANŽOVÁ, KABEL - 2m / RED + WHITE + ORANGE, CABLE - 2m / ROT + WEISS + ORANGE, KABEL - 2m / КРАСНАЯ + БЕЛАЯ + ОРАНЖЕВАЯ, КАБЕЛЬ - 2м	31-3104-017	
724204 LEVÁ / LEFT / LINKS / ЛЕВАЯ		SUPERPOINT IV. ČERVENÁ + BILÁ + ORANŽOVÁ, KABEL - 2m / RED + WHITE + ORANGE, CABLE - 2m / ROT + WEISS + ORANGE, KABEL - 2m / КРАСНАЯ + БЕЛАЯ + ОРАНЖЕВАЯ, КАБЕЛЬ - 2м	31-3104-007	
721468		P&R / P&R CLICK / P&R KLICKEN / P&R	4260089	

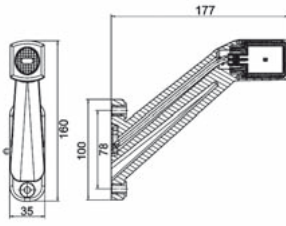
LED 24V OBRYSOVÁ SVĚTLA / LED 24V OUTLINE MARKER LAMPS /
LED 24V UMRISSELEUCHTEN / ДИОДНЫЕ КОНТУРНЫЕ ЛАМПЫ 24V

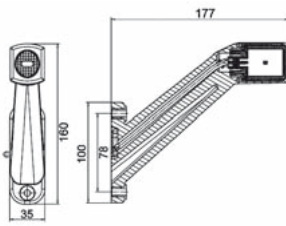
KÓD / ORDER CODE / BESTELL NR. / КОД		POPIS / DESCRIPTION / BESCHREIBUNG / ОПИСАНИЕ	OE / OE NUMBER / OE NUMMER / OE	NÁKRES / DRAWING / ZEICHNUNG / ЧЕРТЕЖ
<p>720785 PRAVÁ / RIGHT / RECHTS / ПРАВАЯ</p>		<p>ČERVENÁ + BÍLÁ + ORANŽOVÁ, KABEL - 0,5m / RED + WHITE + ORANGE, CABLE - 0,5m / ROT + WEISS + ORANGE, KABEL - 0,5m / КРАСНАЯ + БЕЛАЯ + ОРАНЖЕВАЯ, КАБЕЛЬ - 0,5м</p>	<p>2XS011744-021</p>	
<p>720786 LEVÁ / LEFT / LINKS / ЛЕВАЯ</p>		<p>ČERVENÁ + BÍLÁ + ORANŽOVÁ, KABEL - 0,5m / RED + WHITE + ORANGE, CABLE - 0,5m / ROT + WEISS + ORANGE, KABEL - 0,5m / КРАСНАЯ + БЕЛАЯ + ОРАНЖЕВАЯ, КАБЕЛЬ - 0,5м</p>	<p>2XS011744-011</p>	

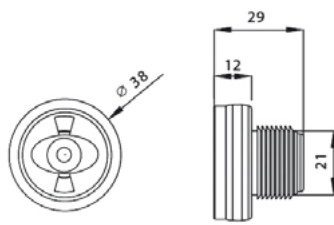

**LED 12-24V POZIČNÍ SVĚTLA / LED 12-24V MARKER LAMPS /
LED 12-24V POSITIONSLEUCHTEN / ДИОДНЫЕ ГАБАРИТНЫЕ ЛАМПЫ 12-24V**

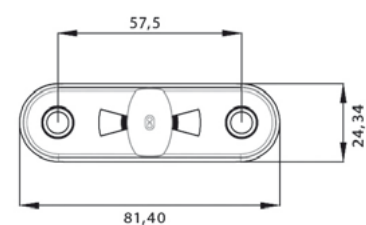
KÓD / ORDER CODE / BESTELL NR. / КОД	POPIS / DESCRIPTION / BESCHREIBUNG / ОПИСАНИЕ	OE / OE NUMBER / OE NUMMER / OE	NÁKRES / DRAWING / ZEICHNUNG / ЧЕРТЁЖ
726993	MONOPOINT II. KABEL / CABLE / KABEL / КАБЕЛЬ - 3,5m	31-6700-027	

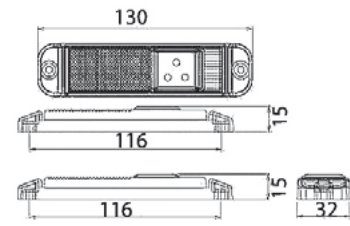

KÓD / ORDER CODE / BESTELL NR. / КОД	POPIS / DESCRIPTION / BESCHREIBUNG / ОПИСАНИЕ	OE / OE NUMBER / OE NUMMER / OE	NÁKRES / DRAWING / ZEICHNUNG / ЧЕРТЁЖ
726966	POSIPOINT II. KABEL / CABLE / KABEL / КАБЕЛЬ - 0,5m	31-7104-007	
726961	POUZDRO / HOUSING / GEHÄUSE / ШАЙБА	15-5609-107	
721468	P&R / P&R CLICK / P&R KLICKEN / P&R	4260089	

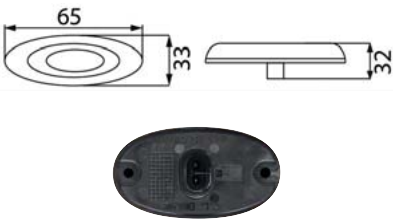

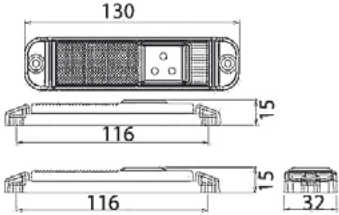

KÓD / ORDER CODE / BESTELL NR. / КОД	POPIS / DESCRIPTION / BESCHREIBUNG / ОПИСАНИЕ	OE / OE NUMBER / OE NUMMER / OE	NÁKRES / DRAWING / ZEICHNUNG / ЧЕРТЁЖ
726009	3x LED, KABEL - 0,95m / 3x LEDs, CABLE - 0,95m / 3x LEUCHTENDIODEN, KABEL - 0,95m / 3x СВЕТОДИОДНЫЙ, КАБЕЛЬ - 0,95м		

**LED 12-24V POZIČNÍ SVĚTLA / LED 12-24V MARKER LAMPS /
LED 12-24V POSITIONSLEUCHTEN / ДИОДНЫЕ ГАБАРИТНЫЕ ЛАМПЫ 12-24V**

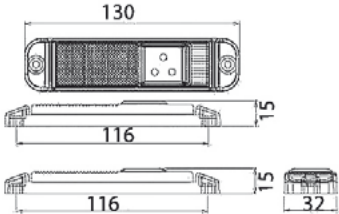
KÓD / ORDER CODE / BESTELL NR. / КОД		POPIS / DESCRIPTION / BESCHREIBUNG / ОПИСАНИЕ	OE / OE NUMBER / OE NUMMER / OE	NÁKRES / DRAWING / ZEICHNUNG / ЧЕРТЁЖ
722842		2x LED / 2x LEDS / 2x LEUCHTENDIODEN / 2x СВЕТОДИОДНЫЙ	850 /01 /04	
720019		OPRAVNÁ SADA / REPAIR KIT / ANSCHLUSSSATZ / РЕМОНТНЫЙ КОМПЛЕКТ		

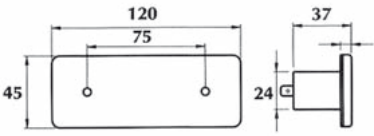
**LED 12-24V POZIČNÍ SVĚTLA / LED 12-24V MARKER LAMPS /
LED 12-24V POSITIONSLEUCHTEN / ДИОДНЫЕ ГАБАРИТНЫЕ ЛАМПЫ 12-24V**

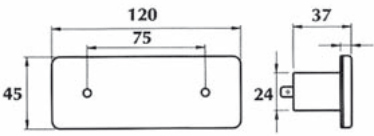
KÓD / ORDER CODE / BESTELL NR. / КОД		POPIS / DESCRIPTION / BESCHREIBUNG / ОПИСАНИЕ	OE / OE NUMBER / OE NUMMER / OE	NÁKRES / DRAWING / ZEICHNUNG / ЧЕРТЁЖ
725954		3x LED, KABEL - 0,95m / 3x LEADS, CABLE - 0,95m / 3x LEUCHTENDIODEN, KABEL - 0,95m / 3x СВЕТОДИОДНЫЙ, КАБЕЛЬ - 0,95м		
725979		3x LED, KABEL - 0,95m / 3x LEADS, CABLE - 0,95m / 3x LEUCHTENDIODEN, KABEL - 0,95m / 3x СВЕТОДИОДНЫЙ, КАБЕЛЬ - 0,95м		

KÓD / ORDER CODE / BESTELL NR. / КОД		POPIS / DESCRIPTION / BESCHREIBUNG / ОПИСАНИЕ	OE / OE NUMBER / OE NUMMER / OE	NÁKRES / DRAWING / ZEICHNUNG / ЧЕРТЁЖ
726548		1x LED, P&R KABEL - 0,5m / 1x LEADS, P&R CABLE - 0,5m / 1x LEUCHTENDIODEN, P&R KABEL - 0,5m / 1x СВЕТОДИОДНЫЙ, P&R КАБЕЛЬ - 0,5м		
726549		1x LED, P&R KABEL - 0,5m / 1x LEADS, P&R CABLE - 0,5m / 1x LEUCHTENDIODEN, P&R KABEL - 0,5m / 1x СВЕТОДИОДНЫЙ, P&R КАБЕЛЬ - 0,5м		
721468		P&R / P&R CLICK / P&R KLICKEN / P&R	4260089	

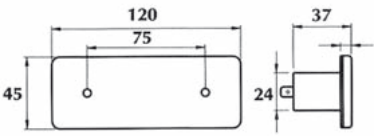
KÓD / ORDER CODE / BESTELL NR. / КОД		POPIS / DESCRIPTION / BESCHREIBUNG / ОПИСАНИЕ	OE / OE NUMBER / OE NUMMER / OE	NÁKRES / DRAWING / ZEICHNUNG / ЧЕРТЁЖ
721805		1x LED, KABEL - 0,5m / 1x LEADS, CABLE - 0,5m / 1x LEUCHTENDIODEN, KABEL - 0,5m / 1x СВЕТОДИОДНЫЙ, КАБЕЛЬ - 0,5м		

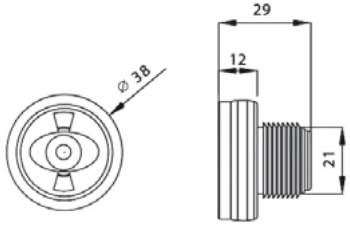

**LED 12-24V POZIČNÍ SVĚTLA / LED 12-24V MARKER LAMPS /
LED 12-24V POSITIONSLEUCHTEN / ДИОДНЫЕ ГАБАРИТНЫЕ ЛАМПЫ 12-24V**

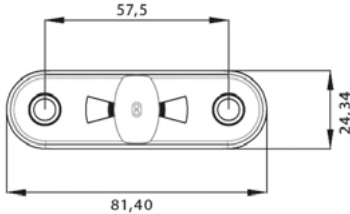
KÓD / ORDER CODE / BESTELL NR. / КОД	POPIS / DESCRIPTION / BESCHREIBUNG / ОПИСАНИЕ	OE / OE NUMBER / OE NUMMER / OE	NÁKRES / DRAWING / ZEICHNUNG / ЧЕРТЁЖ
724021	MONOPOINT II. KABEL / CABLE / KABEL / КАБЕЛЬ - 3,5m	31-6800-017	

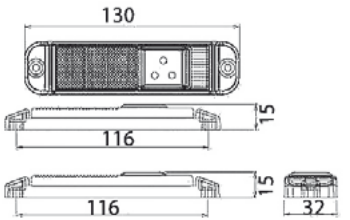



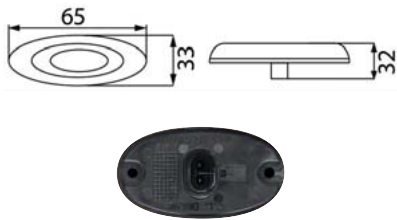

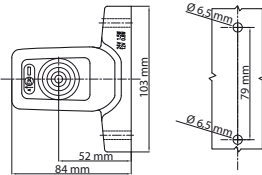

KÓD / ORDER CODE / BESTELL NR. / КОД	POPIS / DESCRIPTION / BESCHREIBUNG / ОПИСАНИЕ	OE / OE NUMBER / OE NUMMER / OE	NÁKRES / DRAWING / ZEICHNUNG / ЧЕРТЁЖ
726964	POSIPOINT II. KABEL / CABLE / KABEL / КАБЕЛЬ - 0,5m	31-7204-007	
726961	POUZDRO / HOUSING / GEHÄUSE / ШАЙБА	15-5609-107	
721468	P&R / P&R CLICK / P&R KLICKEN / P&R	4260089	

KÓD / ORDER CODE / BESTELL NR. / КОД	POPIS / DESCRIPTION / BESCHREIBUNG / ОПИСАНИЕ	OE / OE NUMBER / OE NUMMER / OE	NÁKRES / DRAWING / ZEICHNUNG / ЧЕРТЁЖ
726006	3x LED, KABEL - 0,95m / 3x LEDES, CABLE - 0,95m / 3x LEUCHTENDIODEN, KABEL - 0,95m / 3x СВЕТОДИОДНЫЙ, КАБЕЛЬ - 0,95м		

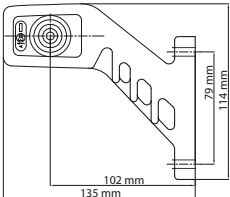
**LED 12-24V POZIČNÍ SVĚTLA / LED 12-24V MARKER LAMPS /
LED 12-24V POSITIONSLEUCHTEN / ДИОДНЫЕ ГАБАРИТНЫЕ ЛАМПЫ 12-24V**

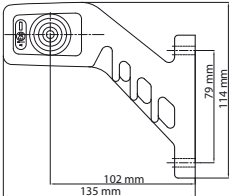

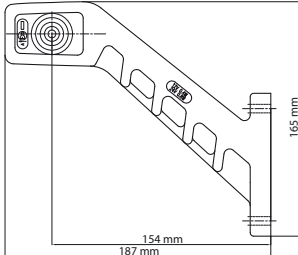

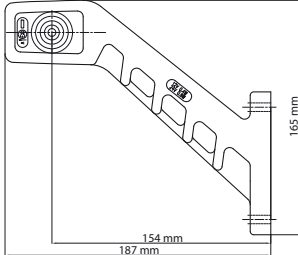
KÓD / ORDER CODE / BESTELL NR. / КОД		POPIS / DESCRIPTION / BESCHREIBUNG / ОПИСАНИЕ	OE / OE NUMBER / OE NUMMER / OE	NÁKRES / DRAWING / ZEICHNUNG / ЧЕРТЁЖ
722843		2x LED / 2x LEDs / 2x LEUCHTENDIODEN / 2x СВЕТОДИОДНЫЙ	850 /02 /04	
720019		OPRAVNÁ SADA / REPAIR KIT / ANSCHLUSSSATZ / РЕМОНТНЫЙ КОМПЛЕКТ		

LED OBRYSOVÁ SVĚTLA 12-24V / LED 12-24V OUTLINE MARKER LAMPS / LED 12-24V UMRISSELEUCHTEN / ДИОДНЫЕ КОНТУРНЫЕ ЛАМПЫ 12-24V

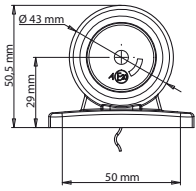







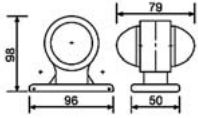

KÓD / ORDER CODE / BESTELL NR. / КОД		POPIS / DESCRIPTION / BESCHREIBUNG / ОПИСАНИЕ	OE / OE NUMBER / OE NUMMER / OE	NÁKRES / DRAWING / ZEICHNUNG / ЧЕРТЁЖ
721381		ČERVENÁ + BÍLÁ + ORANŽOVÁ, KABEL - 0,2m / RED + WHITE + ORANGE, CABLE - 0,2m / ROT + WEISS + ORANGE, KABEL - 0,2m / КРАСНАЯ + БЕЛАЯ + ОРАНЖЕВАЯ, КАБЕЛЬ - 0,2м		
726725 PRAVÁ / RIGHT / RECHTS / ПРАВАЯ		ČERVENÁ + BÍLÁ + ORANŽOVÁ, KABEL - 0,2m / RED + WHITE + ORANGE, CABLE - 0,2m / ROT + WEISS + ORANGE, KABEL - 0,2m / КРАСНАЯ + БЕЛАЯ + ОРАНЖЕВАЯ, КАБЕЛЬ - 0,2м		
726729 LEVÁ / LEFT / LINKS / ЛЕВАЯ		ČERVENÁ + BÍLÁ + ORANŽOVÁ, KABEL - 0,2m / RED + WHITE + ORANGE, CABLE - 0,2m / ROT + WEISS + ORANGE, KABEL - 0,2m / КРАСНАЯ + БЕЛАЯ + ОРАНЖЕВАЯ, КАБЕЛЬ - 0,2м		
726723 PRAVÁ / RIGHT / RECHTS / ПРАВАЯ		ČERVENÁ + BÍLÁ + ORANŽOVÁ, KABEL - 0,2m / RED + WHITE + ORANGE, CABLE - 0,2m / ROT + WEISS + ORANGE, KABEL - 0,2m / КРАСНАЯ + БЕЛАЯ + ОРАНЖЕВАЯ, КАБЕЛЬ - 0,2м		
726724 LEVÁ / LEFT / LINKS / ЛЕВАЯ		ČERVENÁ + BÍLÁ + ORANŽOVÁ, KABEL - 0,2m / RED + WHITE + ORANGE, CABLE - 0,2m / ROT + WEISS + ORANGE, KABEL - 0,2m / КРАСНАЯ + БЕЛАЯ + ОРАНЖЕВАЯ, КАБЕЛЬ - 0,2м		

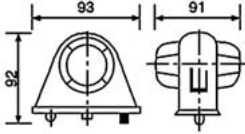
LED OBRYSOVÁ SVĚTLA 12-24V / LED 12-24V OUTLINE MARKER LAMPS / LED 12-24V UMRISSELEUCHTEN / ДИОДНЫЕ КОНТУРНЫЕ ЛАМПЫ 12-24V

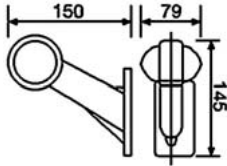

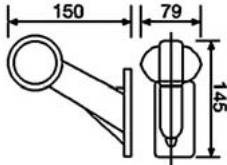

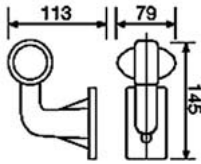

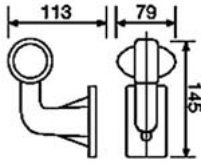

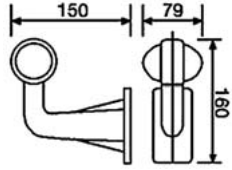

KÓD / ORDER CODE / BESTELL NR. / КОД		POPIS / DESCRIPTION / BESCHREIBUNG / ОПИСАНИЕ	OE / OE NUMBER / OE NUMMER / OE	NÁKRES / DRAWING / ZEICHNUNG / ЧЕРТЕЖ
721389		ČERVENÁ + BÍLÁ KABEL - 0,2m / RED + WHITE CABLE - 0,2m / ROT + WEISS KABEL - 0,2m / КРАСНАЯ + БЕЛАЯ КАБЕЛЬ - 0,2м		

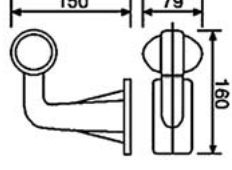
KÓD / ORDER CODE / BESTELL NR. / КОД		POPIS / DESCRIPTION / BESCHREIBUNG / ОПИСАНИЕ	OE / OE NUMBER / OE NUMMER / OE	NÁKRES / DRAWING / ZEICHNUNG / ЧЕРТЕЖ
721419 PRAVÁ / RIGHT / RECHTS / ПРАВАЯ		ČERVENÁ + BÍLÁ, PRYZOVÉ RAMENO 60°, KABEL - 0,3m / RED + WHITE, RUBBER ARM 60°, CABLE - 0,3m / ROT + WEISS, GUMMIARM 60°, KABEL - 0,3m / КРАСНАЯ + БЕЛАЯ, РЕЗИНОВЫЙ РУКАВ 60°, КАБЕЛЬ - 0,3м		DĚLKA - 140mm, ROZTEČ ŠROUBŮ - 80mm / LENGTH - 140mm, BOLTS PITCH - 80mm / LÄNGE - 140mm, SCHRAUBEN TONHÖHE - 80mm / ДЛИНА - 140мм, ШАГ РЕЗЬБЫ БОЛТА - 80мм
721420 LEVÁ / LEFT / LINKS / ЛЕВАЯ		ČERVENÁ + BÍLÁ, PRYZOVÉ RAMENO 60°, KABEL - 0,3m / RED + WHITE, RUBBER ARM 60°, CABLE - 0,3m / ROT + WEISS, GUMMIARM 60°, KABEL - 0,3m / КРАСНАЯ + БЕЛАЯ, РЕЗИНОВЫЙ РУКАВ 60°, КАБЕЛЬ - 0,3м		DĚLKA - 140mm, ROZTEČ ŠROUBŮ - 80mm / LENGTH - 140mm, BOLTS PITCH - 80mm / LÄNGE - 140mm, SCHRAUBEN TONHÖHE - 80mm / ДЛИНА - 140мм, ШАГ РЕЗЬБЫ БОЛТА - 80мм
721421 PRAVÁ / RIGHT / RECHTS / ПРАВАЯ		ČERVENÁ + BÍLÁ + ORANŽOVÁ, PRYZOVÉ RAMENO 60°, KABEL - 0,3m / RED + WHITE + ORANGE, RUBBER ARM 60°, CABLE - 0,3m / ROT + WEISS + ORANGE, GUMMIARM 60°, KABEL - 0,3m / КРАСНАЯ + БЕЛАЯ + ОРАНЖЕВАЯ, РЕЗИНОВЫЙ РУКАВ 60°, КАБЕЛЬ - 0,3м		DĚLKA - 140mm, ROZTEČ ŠROUBŮ - 80mm / LENGTH - 140mm, BOLTS PITCH - 80mm / LÄNGE - 140mm, SCHRAUBEN TONHÖHE - 80mm / ДЛИНА - 140мм, ШАГ РЕЗЬБЫ БОЛТА - 80мм
721422 LEVÁ / LEFT / LINKS / ЛЕВАЯ		ČERVENÁ + BÍLÁ + ORANŽOVÁ, PRYZOVÉ RAMENO 60°, KABEL - 0,3m / RED + WHITE + ORANGE, RUBBER ARM 60°, CABLE - 0,3m / ROT + WEISS + ORANGE, GUMMIARM 60°, KABEL - 0,3m / КРАСНАЯ + БЕЛАЯ + ОРАНЖЕВАЯ, РЕЗИНОВЫЙ РУКАВ 60°, КАБЕЛЬ - 0,3м		DĚLKA - 140mm, ROZTEČ ŠROUBŮ - 80mm / LENGTH - 140mm, BOLTS PITCH - 80mm / LÄNGE - 140mm, SCHRAUBEN TONHÖHE - 80mm / ДЛИНА - 140мм, ШАГ РЕЗЬБЫ БОЛТА - 80мм

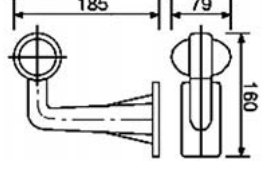

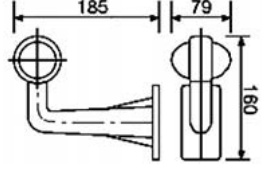

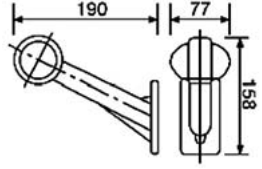

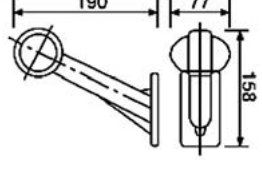

**LED OBRYSOVÁ SVĚTLA 12-24V / LED 12-24V OUTLINE MARKER LAMPS /
LED 12-24V UMRISSELEUCHTEN / ДИОДНЫЕ КОНТУРНЫЕ ЛАМПЫ 12-24V**

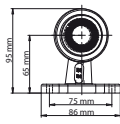
KÓD / ORDER CODE / BESTELL NR. / КОД		POPIS / DESCRIPTION / BESCHREIBUNG / ОПИСАНИЕ	OE / OE NUMBER / OE NUMMER / OE	NÁKRES / DRAWING / ZEICHNUNG / ЧЕРТЁЖ
723705		<p>ČERVENÁ + BÍLÁ, PRYZOVÉ RAMENO, KABEL - 0,15m / RED + WHITE, RUBBER ARM, CABLE - 0,15m / ROT + WEISS, GUMMIARM, KABEL - 0,15m / КРАСНАЯ + БЕЛАЯ, РЕЗИНОВЫЙ РУКАВ, КАБЕЛЬ - 0,15м</p>		
727330		<p>ČERVENÁ + BÍLÁ, PRYZOVÉ RAMENO, KABEL - 0,15m / RED + WHITE, RUBBER ARM, CABLE - 0,15m / ROT + WEISS, GUMMIARM, KABEL - 0,15m / КРАСНАЯ + БЕЛАЯ, РЕЗИНОВЫЙ РУКАВ, КАБЕЛЬ - 0,15м</p>		
723706 PRAVÁ / RIGHT / RECHTS / ПРАВАЯ		<p>ČERVENÁ + BÍLÁ, PRYZOVÉ RAMENO 60°, KABEL - 0,15m / RED + WHITE, RUBBER ARM 60°, CABLE - 0,15m / ROT + WEISS, GUMMIARM 60°, KABEL - 0,15m / КРАСНАЯ + БЕЛАЯ, РЕЗИНОВЫЙ РУКАВ 60°, КАБЕЛЬ - 0,15м</p>		
723707 LEVÁ / LEFT / LINKS / ЛЕВАЯ		<p>ČERVENÁ + BÍLÁ, PRYZOVÉ RAMENO 60°, KABEL - 0,15m / RED + WHITE, RUBBER ARM 60°, CABLE - 0,15m / ROT + WEISS, GUMMIARM 60°, KABEL - 0,15m / КРАСНАЯ + БЕЛАЯ, РЕЗИНОВЫЙ РУКАВ 60°, КАБЕЛЬ - 0,15м</p>		
723712 PRAVÁ / RIGHT / RECHTS / ПРАВАЯ		<p>ČERVENÁ + BÍLÁ, PRYZOVÉ RAMENO 90°, KABEL - 0,15m / RED + WHITE, RUBBER ARM 90°, CABLE - 0,15m / ROT + WEISS, GUMMIARM 90°, KABEL - 0,15m / КРАСНАЯ + БЕЛАЯ, РЕЗИНОВЫЙ РУКАВ 90°, КАБЕЛЬ - 0,15м</p>		
723713 LEVÁ / LEFT / LINKS / ЛЕВАЯ		<p>ČERVENÁ + BÍLÁ, PRYZOVÉ RAMENO 90°, KABEL - 0,15m / RED + WHITE, RUBBER ARM 90°, CABLE - 0,15m / ROT + WEISS, GUMMIARM 90°, KABEL - 0,15m / КРАСНАЯ + БЕЛАЯ, РЕЗИНОВЫЙ РУКАВ 90°, КАБЕЛЬ - 0,15м</p>		

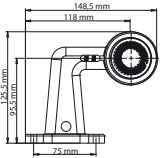

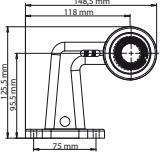

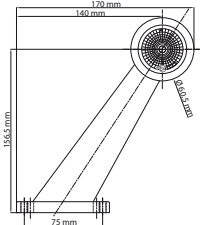

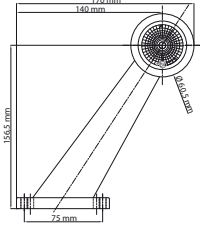
**LED OBRYSOVÁ SVĚTLA 12-24V / LED 12-24V OUTLINE MARKER LAMPS /
LED 12-24V UMRISSELEUCHTEN / ДИОДНЫЕ КОНТУРНЫЕ ЛАМПЫ 12-24V**

KÓD / ORDER CODE / BESTELL NR. / КОД		POPIS / DESCRIPTION / BESCHREIBUNG / ОПИСАНИЕ	OE / OE NUMBER / OE NUMMER / OE	NÁKRES / DRAWING / ZEICHNUNG / ЧЕРТЕЖ
<p>723708 PRAVÁ / RIGHT / RECHTS / ПРАВАЯ</p>		<p>ČERVENÁ + BÍLÁ, PRYZOVÉ RAMENO 90°, KABEL - 0,15m / RED + WHITE, RUBBER ARM 90°, CABLE - 0,15m / ROT + WEISS, GUMMIARM 90°, KABEL - 0,15m / КРАСНАЯ + БЕЛАЯ, РЕЗИНОВЫЙ РУКАВ 90°, КАБЕЛЬ - 0,15м</p>		
<p>723709 LEVÁ / LEFT / LINKS / ЛЕВАЯ</p>		<p>ČERVENÁ + BÍLÁ, PRYZOVÉ RAMENO 90°, KABEL - 0,15m / RED + WHITE, RUBBER ARM 90°, CABLE - 0,15m / ROT + WEISS, GUMMIARM 90°, KABEL - 0,15m / КРАСНАЯ + БЕЛАЯ, РЕЗИНОВЫЙ РУКАВ 90°, КАБЕЛЬ - 0,15м</p>		
<p>723710 PRAVÁ / RIGHT / RECHTS / ПРАВАЯ</p>		<p>ČERVENÁ + BÍLÁ, PRYZOVÉ RAMENO 90°, KABEL - 0,15m / RED + WHITE, RUBBER ARM 90°, CABLE - 0,15m / ROT + WEISS, GUMMIARM 90°, KABEL - 0,15m / КРАСНАЯ + БЕЛАЯ, РЕЗИНОВЫЙ РУКАВ 90°, КАБЕЛЬ - 0,15м</p>		
<p>723711 LEVÁ / LEFT / LINKS / ЛЕВАЯ</p>		<p>ČERVENÁ + BÍLÁ, PRYZOVÉ RAMENO 90°, KABEL - 0,15m / RED + WHITE, RUBBER ARM 90°, CABLE - 0,15m / ROT + WEISS, GUMMIARM 90°, KABEL - 0,15m / КРАСНАЯ + БЕЛАЯ, РЕЗИНОВЫЙ РУКАВ 90°, КАБЕЛЬ - 0,15м</p>		
<p>723718 PRAVÁ / RIGHT / RECHTS / ПРАВАЯ</p>		<p>ČERVENÁ + BÍLÁ, PRYZOVÉ RAMENO, KABEL - 0,15m / RED + WHITE, RUBBER ARM, CABLE - 0,15m / ROT + WEISS, GUMMIARM, KABEL - 0,15m / КРАСНАЯ + БЕЛАЯ, РЕЗИНОВЫЙ РУКАВ, КАБЕЛЬ - 0,15м</p>		
<p>723719 LEVÁ / LEFT / LINKS / ЛЕВАЯ</p>		<p>ČERVENÁ + BÍLÁ, PRYZOVÉ RAMENO, KABEL - 0,15m / RED + WHITE, RUBBER ARM, CABLE - 0,15m / ROT + WEISS, GUMMIARM, KABEL - 0,15m / КРАСНАЯ + БЕЛАЯ, РЕЗИНОВЫЙ РУКАВ, КАБЕЛЬ - 0,15м</p>		

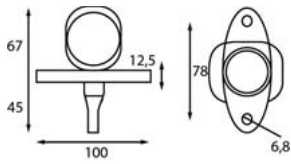
LED OBRYSOVÁ SVĚTLA 12-24V / LED 12-24V OUTLINE MARKER LAMPS / LED 12-24V UMRISSELEUCHTEN / ДИОДНЫЕ КОНТУРНЫЕ ЛАМПЫ 12-24V

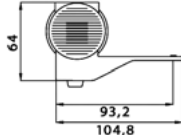
KÓD / ORDER CODE / BESTELL NR. / КОД		POPIS / DESCRIPTION / BESCHREIBUNG / ОПИСАНИЕ	OE / OE NUMBER / OE NUMMER / OE	NÁKRES / DRAWING / ZEICHNUNG / ЧЕРТЁЖ
721382		<p>ČERVENÁ + BÍLÁ KABEL - 0,2m / RED + WHITE CABLE - 0,2m / ROT + WEISS KABEL - 0,2m / КРАСНАЯ + БЕЛАЯ КАБЕЛЬ - 0,2м</p>		
721387 PRAVÁ / RIGHT / RECHTS / ПРАВАЯ		<p>ČERVENÁ + BÍLÁ, PRYŽOVÉ RAMENO 90°, KABEL - 0,2m / RED + WHITE, RUBBER ARM 90°, CABLE - 0,2m / ROT + WEISS, GUMMIARM 90°, KABEL - 0,2m / КРАСНАЯ + БЕЛАЯ, РЕЗИНОВЫЙ РУКАВ 90°, КАБЕЛЬ - 0,2м</p>		
721388 LEVÁ / LEFT / LINKS / ЛЕВАЯ		<p>ČERVENÁ + BÍLÁ, PRYŽOVÉ RAMENO 90°, KABEL - 0,2m / RED + WHITE, RUBBER ARM 90°, CABLE - 0,2m / ROT + WEISS, GUMMIARM 90°, KABEL - 0,2m / КРАСНАЯ + БЕЛАЯ, РЕЗИНОВЫЙ РУКАВ 90°, КАБЕЛЬ - 0,2м</p>		
721385 PRAVÁ / RIGHT / RECHTS / ПРАВАЯ		<p>ČERVENÁ + BÍLÁ, PRYŽOVÉ RAMENO 60°, KABEL - 0,2m / RED + WHITE, RUBBER ARM 60°, CABLE - 0,2m / ROT + WEISS, GUMMIARM 60°, KABEL - 0,2m / КРАСНАЯ + БЕЛАЯ, РЕЗИНОВЫЙ РУКАВ 60°, КАБЕЛЬ - 0,2м</p>		
721386 LEVÁ / LEFT / LINKS / ЛЕВАЯ		<p>ČERVENÁ + BÍLÁ, PRYŽOVÉ RAMENO 60°, KABEL - 0,2m / RED + WHITE, RUBBER ARM 60°, CABLE - 0,2m / ROT + WEISS, GUMMIARM 60°, KABEL - 0,2m / КРАСНАЯ + БЕЛАЯ, РЕЗИНОВЫЙ РУКАВ 60°, КАБЕЛЬ - 0,2м</p>		

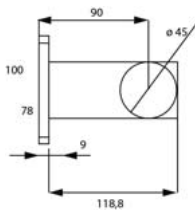
**LED OBRYSOVÁ SVĚTLA 12-24V / LED 12-24V OUTLINE MARKER LAMPS /
LED 12-24V UMRISSELEUCHTEN / ДИОДНЫЕ КОНТУРНЫЕ ЛАМПЫ 12-24V**

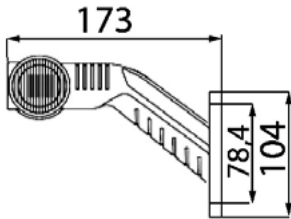

KÓD / ORDER CODE / BESTELL NR. / КОД		POPIS / DESCRIPTION / BESCHREIBUNG / ОПИСАНИЕ	OE / OE NUMBER / OE NUMMER / OE	NÁKRES / DRAWING / ZEICHNUNG / ЧЕРТЁЖ
721367		<p>1 PÁR, ČERVENÁ + BILÁ + ORANŽOVÁ, PRYZŮVÉ RAMENO, KABEL - 1,7m / 1x PAIR, RED + WHITE + ORANGE, RUBBER ARM, CABLE - 1,7m / 1x PAAR, ROT + WEISS + ORANGE, GUMMIARM KABEL - 1,7m / 1 ПАРА, КРАСНАЯ + БЕЛАЯ + ОРАНЖЕВАЯ, РЕЗИНОВЫЙ РУКАВ, ПРОВОД - 1,7м</p>		
721368		<p>1 PÁR, ČERVENÁ + BILÁ + ORANŽOVÁ, PRYZŮVÉ RAMENO, KABEL - 1,7m / 1x PAIR, RED + WHITE + ORANGE, RUBBER ARM, CABLE - 1,7m / 1x PAAR, ROT + WEISS + ORANGE, GUMMIARM KABEL - 1,7m / 1 ПАРА, КРАСНАЯ + БЕЛАЯ + ОРАНЖЕВАЯ, РЕЗИНОВЫЙ РУКАВ, ПРОВОД - 1,7м</p>		
721366		<p>1 PÁR, ČERVENÁ + BILÁ + ORANŽOVÁ, PRYZŮVÉ RAMENO, KABEL - 1,7m / 1x PAIR, RED + WHITE + ORANGE, RUBBER ARM, CABLE - 1,7m / 1x PAAR, ROT + WEISS + ORANGE, GUMMIARM KABEL - 1,7m / 1 ПАРА, КРАСНАЯ + БЕЛАЯ + ОРАНЖЕВАЯ, РЕЗИНОВЫЙ РУКАВ, ПРОВОД - 1,7м</p>		
721365		<p>1 PÁR, ČERVENÁ + BILÁ + ORANŽOVÁ, PRYZŮVÉ RAMENO, KABEL - 1,7m / 1x PAIR, RED + WHITE + ORANGE, RUBBER ARM, CABLE - 1,7m / 1x PAAR, ROT + WEISS + ORANGE, GUMMIARM KABEL - 1,7m / 1 ПАРА, КРАСНАЯ + БЕЛАЯ + ОРАНЖЕВАЯ, РЕЗИНОВЫЙ РУКАВ, ПРОВОД - 1,7м</p>		

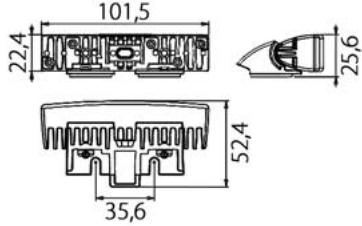
VÝSTRAŽNÁ LED SVĚTLA / FLASHING LED LAMPS /
BLINKENDE LAMPE LED / СИГНАЛЬНАЯ ДИОДНЫЕ ЛАМПА

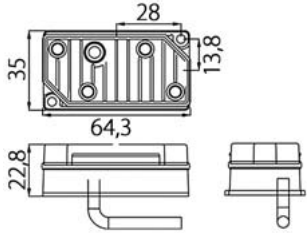
KÓD / ORDER CODE / BESTELL NR. / КОД		POPIS / DESCRIPTION / BESCHREIBUNG / ОПИСАНИЕ	OE / OE NUMBER / OE NUMMER / OE	NÁKRES / DRAWING / ZEICHNUNG / ЧЕРТЁЖ
722391		9-33V LED VÝSTRAŽNÉ SVĚTLO - ORANŽOVÉ, 6x LED, KABEL - 0,3m / FLASHING LED LAMP - ORANGE, WITH 6x LED DIOD, CABLE - 0,3m / BLINKENDE LED - ORANGE, LAMPE 6x LED, KABEL - 0,3m / СВЕТОДИОДНАЯ СИГНАЛЬНАЯ ЛАМПА СВЕТЛО - ОРАНЖОВЕВА, 6-ТИ ДИОДНАЯ, ПРОВОД - 0,3м		

KÓD / ORDER CODE / BESTELL NR. / КОД		POPIS / DESCRIPTION / BESCHREIBUNG / ОПИСАНИЕ	OE / OE NUMBER / OE NUMMER / OE	NÁKRES / DRAWING / ZEICHNUNG / ЧЕРТЁЖ
722389		9-33V LED VÝSTRAŽNÉ SVĚTLO - ORANŽOVÉ, 3x LED, KABEL - 0,5m / FLASHING LED LAMP - ORANGE, WITH 3x LED DIOD, CABLE - 0,5m / BLINKENDE LED - ORANGE, LAMPE 3x LED, KABEL - 0,5m / СВЕТОДИОДНАЯ СИГНАЛЬНАЯ ЛАМПА СВЕТЛО - ОРАНЖЕВАЯ, 3x ДИОДНАЯ, ПРОВОД - 0,5м		

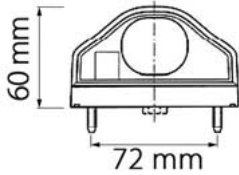
OSVĚTLENÍ SPZ / ILLUMINATION FOR NUMBERPLATE /
KENNZEICHENLEUCHTE / ФОНАРЬ ПОДСВЕТКИ НОМЕРНОГО ЗНАКА

KÓD / ORDER CODE / BESTELL NR. / КОД		POPIS / DESCRIPTION / BESCHREIBUNG / ОПИСАНИЕ	OE / OE NUMBER / OE NUMMER / OE	NÁKRES / DRAWING / ZEICHNUNG / ЧЕРТЁЖ						
720486		KABEL / CABLE / KABEL / КАБЕЛЬ - 0,45m	36-3004-017							
721468		P&R / P&R CLICK / P&R KLICKEN / P&R	4260089	<table border="1"> <tr> <td>722940</td> <td>12 V</td> <td>R5W 12V, BA15s</td> </tr> <tr> <td>722941</td> <td>24 V</td> <td>R5W 24V, BA15s</td> </tr> </table>	722940	12 V	R5W 12V, BA15s	722941	24 V	R5W 24V, BA15s
722940	12 V	R5W 12V, BA15s								
722941	24 V	R5W 24V, BA15s								

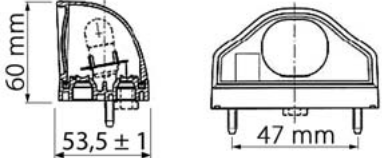
KÓD / ORDER CODE / BESTELL NR. / КОД		POPIS / DESCRIPTION / BESCHREIBUNG / ОПИСАНИЕ	OE / OE NUMBER / OE NUMMER / OE	NÁKRES / DRAWING / ZEICHNUNG / ЧЕРТЁЖ						
724206			196020							
				<table border="1"> <tr> <td>722940</td> <td>12 V</td> <td>R5W 12V, BA15s</td> </tr> <tr> <td>722941</td> <td>24 V</td> <td>R5W 24V, BA15s</td> </tr> </table>	722940	12 V	R5W 12V, BA15s	722941	24 V	R5W 24V, BA15s
722940	12 V	R5W 12V, BA15s								
722941	24 V	R5W 24V, BA15s								

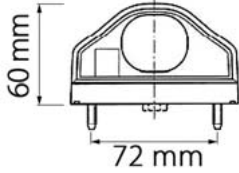
KÓD / ORDER CODE / BESTELL NR. / КОД		POPIS / DESCRIPTION / BESCHREIBUNG / ОПИСАНИЕ	OE / OE NUMBER / OE NUMMER / OE	NÁKRES / DRAWING / ZEICHNUNG / ЧЕРТЁЖ						
724195			26-3010-004							
				<table border="1"> <tr> <td>722950</td> <td>12 V</td> <td>C5W 12V, SV8,5-8</td> </tr> <tr> <td>722951</td> <td>24 V</td> <td>C5W 24V, SV8,5-8</td> </tr> </table>	722950	12 V	C5W 12V, SV8,5-8	722951	24 V	C5W 24V, SV8,5-8
722950	12 V	C5W 12V, SV8,5-8								
722951	24 V	C5W 24V, SV8,5-8								

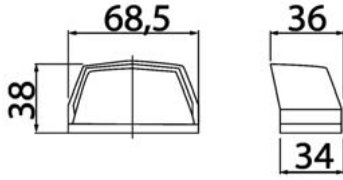
KÓD / ORDER CODE / BESTELL NR. / КОД		POPIS / DESCRIPTION / BESCHREIBUNG / ОПИСАНИЕ	OE / OE NUMBER / OE NUMMER / OE	NÁKRES / DRAWING / ZEICHNUNG / ЧЕРТЁЖ						
727013			610091							
				<table border="1"> <tr> <td>722950</td> <td>12 V</td> <td>C5W 12V, SV8,5-8</td> </tr> <tr> <td>722951</td> <td>24 V</td> <td>C5W 24V, SV8,5-8</td> </tr> </table>	722950	12 V	C5W 12V, SV8,5-8	722951	24 V	C5W 24V, SV8,5-8
722950	12 V	C5W 12V, SV8,5-8								
722951	24 V	C5W 24V, SV8,5-8								

OSVĚTLENÍ SPZ / ILLUMINATION FOR NUMBERPLATE /
KENNZEICHENLEUCHE / ФОНАРЬ ПОДСВЕТКИ НОМЕРНОГО ЗНАКА

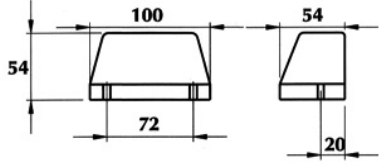

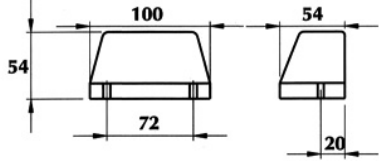

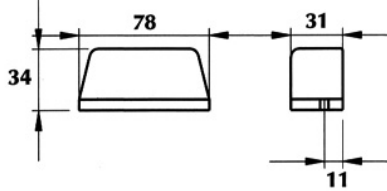
KÓD / ORDER CODE / BESTELL NR. / КОД	POPIS / DESCRIPTION / BESCHREIBUNG / ОПИСАНИЕ	OE / OE NUMBER / OE NUMMER / OE	NÁKRES / DRAWING / ZEICHNUNG / ЧЕРТЁЖ
721908			
			722940 12V R5W 12V, BA15s 722941 24V R5W 24V, BA15s

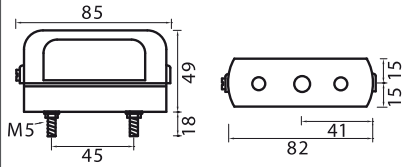
KÓD / ORDER CODE / BESTELL NR. / КОД	POPIS / DESCRIPTION / BESCHREIBUNG / ОПИСАНИЕ	OE / OE NUMBER / OE NUMMER / OE	NÁKRES / DRAWING / ZEICHNUNG / ЧЕРТЁЖ
721909			
			722940 12V R5W 12V, BA15s 722941 24V R5W 24V, BA15s



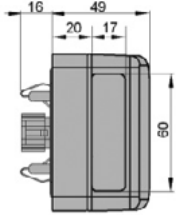

KÓD / ORDER CODE / BESTELL NR. / КОД	POPIS / DESCRIPTION / BESCHREIBUNG / ОПИСАНИЕ	OE / OE NUMBER / OE NUMMER / OE	NÁKRES / DRAWING / ZEICHNUNG / ЧЕРТЁЖ
721945			
			722950 12V C5W 12V, SV8,5-8 722951 24V C5W 24V, SV8,5-8





KÓD / ORDER CODE / BESTELL NR. / КОД	POPIS / DESCRIPTION / BESCHREIBUNG / ОПИСАНИЕ	OE / OE NUMBER / OE NUMMER / OE	NÁKRES / DRAWING / ZEICHNUNG / ЧЕРТЁЖ
727348			
			722950 12V C5W 12V, SV8,5-8 722951 24V C5W 24V, SV8,5-8

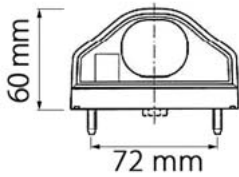

**OSVĚTLENÍ SPZ / ILLUMINATION FOR NUMBERPLATE /
KENNZEICHENLEUCHTE / ФОНАРЬ ПОДСВЕТКИ НОМЕРНОГО ЗНАКА**

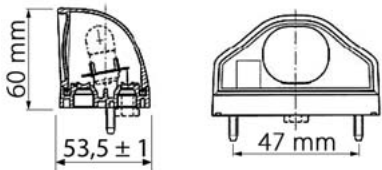

KÓD / ORDER CODE / BESTELL NR. / КОД		POPIS / DESCRIPTION / BESCHREIBUNG / ОПИСАНИЕ	OE / OE NUMBER / OE NUMMER / OE	NÁKRES / DRAWING / ZEICHNUNG / ЧЕРТЁЖ		
720243			02.924.000			
720019		OPRAVNÁ SADA / REPAIR KIT / ANSCHLUSSSATZ / РЕМОНТНЫЙ КОМПЛЕКТ		722940	12 V	R5W 12V, BA15s
				722941	24 V	R5W 24V, BA15s

**LED OSVĚTLENÍ SPZ / LED ILLUMINATION FOR NUMBERPLATE /
LED KENNZEICHENLEUCHE /
ДИОДНЫЙ ФОНАРЬ ПОДСВЕТКИ НОМЕРНОГО ЗНАКА**

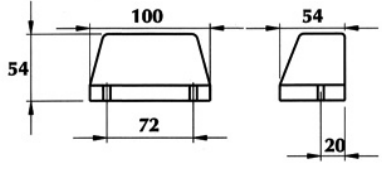

KÓD / ORDER CODE / BESTELL NR. / КОД		POPIS / DESCRIPTION / BESCHREIBUNG / ОПИСАНИЕ	OE / OE NUMBER / OE NUMMER / OE	NÁKRES / DRAWING / ZEICHNUNG / ЧЕРТЁЖ
724194		REGPOINT KABEL / CABLE / КАБЕЛЬ / КАБЕЛЬ - 0,5m 	36-3604-007	
721468		P&R / P&R CLICK / P&R KLICKEN / P&R	4260089	

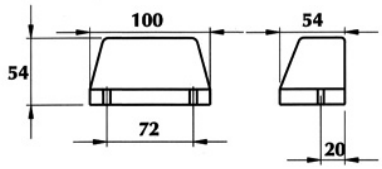

KÓD / ORDER CODE / BESTELL NR. / КОД		POPIS / DESCRIPTION / BESCHREIBUNG / ОПИСАНИЕ	OE / OE NUMBER / OE NUMMER / OE	NÁKRES / DRAWING / ZEICHNUNG / ЧЕРТЁЖ
721744		KABEL / CABLE / КАБЕЛЬ / КАБЕЛЬ - 0,4m 	D13609	
721468		P&R / P&R CLICK / P&R KLICKEN / P&R	4260089	

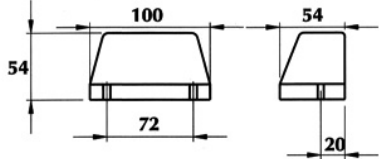

KÓD / ORDER CODE / BESTELL NR. / КОД		POPIS / DESCRIPTION / BESCHREIBUNG / ОПИСАНИЕ	OE / OE NUMBER / OE NUMMER / OE	NÁKRES / DRAWING / ZEICHNUNG / ЧЕРТЁЖ
723051				

KÓD / ORDER CODE / BESTELL NR. / КОД		POPIS / DESCRIPTION / BESCHREIBUNG / ОПИСАНИЕ	OE / OE NUMBER / OE NUMMER / OE	NÁKRES / DRAWING / ZEICHNUNG / ЧЕРТЁЖ
726541				

**LED OSVĚTLENÍ SPZ / LED ILLUMINATION FOR NUMBERPLATE /
LED KENNZEICHENLEUCHTE /
ДИОДНЫЙ ФОНАРЬ ПОДСВЕТКИ НОМЕРНОГО ЗНАКА**

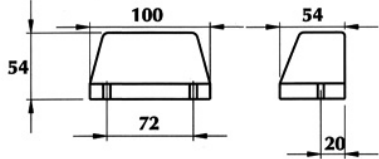
KÓD / ORDER CODE / BESTELL NR. / КОД	POPIS / DESCRIPTION / BESCHREIBUNG / ОПИСАНИЕ	OE / OE NUMBER / OE NUMMER / OE	NÁKRES / DRAWING / ZEICHNUNG / ЧЕРТЁЖ
727296	 		

KÓD / ORDER CODE / BESTELL NR. / КОД	POPIS / DESCRIPTION / BESCHREIBUNG / ОПИСАНИЕ	OE / OE NUMBER / OE NUMMER / OE	NÁKRES / DRAWING / ZEICHNUNG / ЧЕРТЁЖ
727297	 		

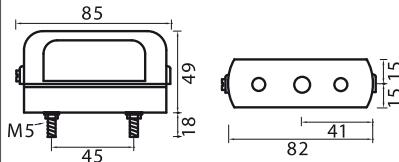
KÓD / ORDER CODE / BESTELL NR. / КОД	POPIS / DESCRIPTION / BESCHREIBUNG / ОПИСАНИЕ	OE / OE NUMBER / OE NUMMER / OE	NÁKRES / DRAWING / ZEICHNUNG / ЧЕРТЁЖ
723040	  <p>KABEL / CABLE / КАБЕЛЬ / КАБЕЛЬ - 0,4m</p>		

**DESKA OS. SPZ LED / NUMBERPLATE HOLDER LED /
KENNZEICHENHALTER LED /
ДИОДНАЯ ПАНЕЛЬ ОСВЕЩЕНИЯ НОМЕРНОГО ЗНАКА**

KÓD / ORDER CODE / BESTELL NR. / КОД		POPIS / DESCRIPTION / BESCHREIBUNG / ОПИСАНИЕ	OE / OE NUMBER / OE NUMMER / OE	NÁKRES / DRAWING / ZEICHNUNG / ЧЕРТЁЖ
721234		3,5m KABEL + 2m KABEL A TŘETÍ BRZDOVÉ SVĚTLO / 3,5m CABLE AND 3 RD STOP LIGHT 2m CABLE OPEN END / 3,5m KABEL UND 3. BREMSLEUCHTE 2m OFFENES ENDE / 3,5м КАБЕЛЬ + 2м КАБЕЛЬ И ТРЕТИЕ ЛАМПА СТОП СИГНАЛА	36-3760-017	

KÓD / ORDER CODE / BESTELL NR. / КОД		POPIS / DESCRIPTION / BESCHREIBUNG / ОПИСАНИЕ	OE / OE NUMBER / OE NUMMER / OE	NÁKRES / DRAWING / ZEICHNUNG / ЧЕРТЁЖ
721235		P&R KABEL / P&R CABLE / P&R KABEL / P&R КАБЕЛЬ - 1 m	36-3764-017	
721468		P&R / P&R CLICK / P&R KLICKEN / P&R	4260089	

WIFI KAMERA + MONITOR

MONITOR

- 7" palcový monitor s vysokým rozlišením (uhlopříčka cca 18 cm)
- Digitální technologie přenosu vysílání s unikátním kódem
- Výrazně potlačena rušivost signálu na rozdíl od analogového vysílání
- Napájení 12-24V
- 8 jazykových verzí (angličtina, němčina, francouzština, portugalština, holandština, italština, španělština a ruština)
- Monitor může být umístěn horizontálně i vertikálně
- PAL / NTSC systém
- Součástí monitoru jsou integrované reproduktory
- Ukazatel vzdálenosti a pruhový graf indikuje přiblížení k překážce z levé nebo pravé strany

KAMERA

- Napájení 12-24V
- Voděodolná kamera (stupeň přilnavosti: IP69)
- Noční vidění až do dálky 10 metrů (to zabezpečuje 12 infračervených LED diod)
- Úhel pohledu 92°
- Použití v teplotách: od -20° do +60°

BALENÍ OBSAHUJE: 1x monitor, 1x držák, 3x svazek kabelů, 1x přípojovací kabel do zapalovače, 1x zadní kamera, 1x podstavec, 1x ovladač, 2x sáčky instalačního materiálu.

KÓD / ORDER CODE /
BESTELL NR. / КОД

720086



WIFI CAMERA + MONITOR

MONITOR

- 7" inch monitor with high resolution (18 cm diagonal)
- Digital transmission technology with a unique code
- Significantly suppressed annoyance signal contrast from analogue broadcasting
- Power supply 12-24V
- With language versions (English, German, French, Portuguese, Dutch, Italian, Spanish and Russian)
- Monitor can be positioned horizontally or vertically
- PAL / NTSC system
- Integrated speakers
- Distance indicator and bar graph indicates approach from the barrier on the left or right side

KAMERA

- Power supply 12-24V
- Waterproof Camera (level of adhesion: IP69)
- Night vision up to 10 meters (this ensures 12 infrared LEDs)
- Angle view 92°
- Apply in temperatures from -20° to +60°

PACKAGE INCLUDES: 1x monitor, 1x holder, 3x wiring harness, 1x connecting cable into the cigarette lighter, 1x rear camera, 1x base, 1x driver, 2 bags with installation materials.

SET 4 KAMER + DOTYKOVÝ DISPLEJ

MONITOR

- Dotykový LCD monitor
- 7" palcový monitor s vysokým rozlišením (uhlopříčka cca 18 cm)
- Napájení 12-24V
- Integrované reproduktory
- Použití v teplotách od -10°C do +65°C

ČELNÍ / BOČNÍ / ZADNÍ KAMERY

- Video standard PAL systém
- Příkon: max. 220 mA
- Voděodolná kamera (stupeň přilnavosti IP69)
- Úhel pohledu 120°
- Použití v teplotách od -20°C do +70°C

KABEL

- Kvalita provedení dle standardů OE dodávek
- Délka 10 a 20m

BALENÍ OBSAHUJE: 4x role přípojovacích kabelů, 3x svazky propojovacích kabelů, 1x monitor + držák, 1x čelní kamera, 2x boční kamera, 1x zadní kamera, 1x podstavec, 1x ovladač, 5x sáčky s instalačním materiálem.

SET 4 CAMERAS + TOUCH SCREEN

MONITOR

- 7" inch LCD touchscreen monitor with high resolution (18 cm diagonal)
- Power supply 12-24V
- Integrated speakers
- Apply in temperatures from -20° to +60°

FRONT / SIDE / REAR CAMERA

- Video standard PAL system
- Power consumption: 220 mA
- Waterproof camera (level of adhesion: IP69)
- Angle view 92°
- Apply in temperatures from -20° to +60°

CABLE

- Quality of the design according to standards of OE deliveries







PACKAGE INCLUDES: 4x roles connecting cables, 3x bundles of connecting cables, 1x monitor + holder, 1x front camera, 2x side camera, 1 rear camera, 1x base, 1x driver, 5x bags with installation material.

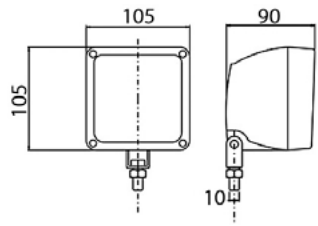

KÓD / ORDER CODE /
BESTELL NR. / КОД

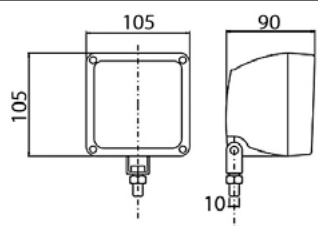

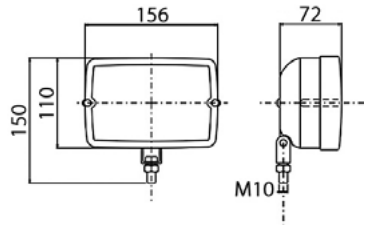

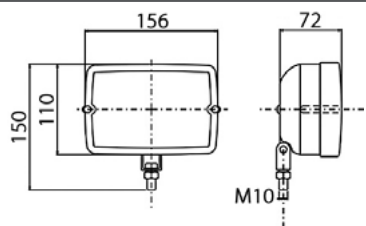
720089

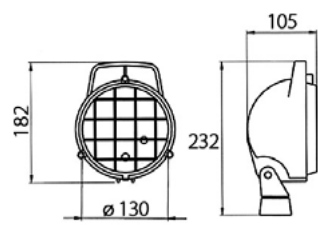
PRACOVNÍ SVĚTLOMETY / WORK LAMPS /
ARBEITSSCHEINWERFER / ФАРЫ РАБОЧЕГО СВЕТА

KÓD / ORDER CODE / BESTELL NR. / КОД		POPIS / DESCRIPTION / BESCHREIBUNG / ОПИСАНИЕ	OE / OE NUMBER / OE NUMMER / OE	NÁKRES / DRAWING / ZEICHNUNG / ЧЕРТЁЖ						
720021		PRŮCHODKA / GROMMET PG / VERSCHRAUBUNG / ОТВЕРСТИЕ ДЛЯ ПРИСОЕДИНЕНИЯ								
725654		2PÓLOVÝ KONEKTOR / 2x POLES CONNECTOR / 2x POLE CONTACT / 2 ПОЛЮСНЫЙ ШТЕКЕР								
720015		PRŮCHODKA / GROMMET PG / VERSCHRAUBUNG / ОТВЕРСТИЕ ДЛЯ ПРИСОЕДИНЕНИЯ								
720016		PRŮCHODKA / GROMMET PG / VERSCHRAUBUNG / ОТВЕРСТИЕ ДЛЯ ПРИСОЕДИНЕНИЯ								
				<table border="1"> <tr> <td>722909</td> <td>12 V</td> <td>H3 12V 55W, PK22s</td> </tr> <tr> <td>722910</td> <td>24 V</td> <td>H3 24V 70W, PK22s</td> </tr> </table>	722909	12 V	H3 12V 55W, PK22s	722910	24 V	H3 24V 70W, PK22s
722909	12 V	H3 12V 55W, PK22s								
722910	24 V	H3 24V 70W, PK22s								

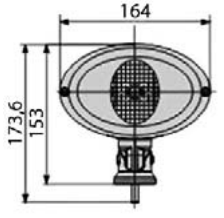
KÓD / ORDER CODE / BESTELL NR. / КОД		POPIS / DESCRIPTION / BESCHREIBUNG / ОПИСАНИЕ	OE / OE NUMBER / OE NUMMER / OE	NÁKRES / DRAWING / ZEICHNUNG / ЧЕРТЁЖ						
720250		PRŮCHODKA A VYPÍNAČ / GROMMET PG AND SWITCH / VERSCHRAUBUNG UND SCHALTER / ОТВЕРСТИЕ ДЛЯ ПРИСОЕДИНЕНИЯ И ВЫКЛЮЧАТЕЛЬ								
727146		KABEL / CABLE / KABEL / КАБЕЛЬ - 0,1 m	05.373.000							
				<table border="1"> <tr> <td>722909</td> <td>12 V</td> <td>H3 12V 55W, PK22s</td> </tr> <tr> <td>722910</td> <td>24 V</td> <td>H3 24V 70W, PK22s</td> </tr> </table>	722909	12 V	H3 12V 55W, PK22s	722910	24 V	H3 24V 70W, PK22s
722909	12 V	H3 12V 55W, PK22s								
722910	24 V	H3 24V 70W, PK22s								

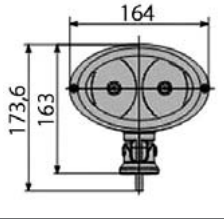

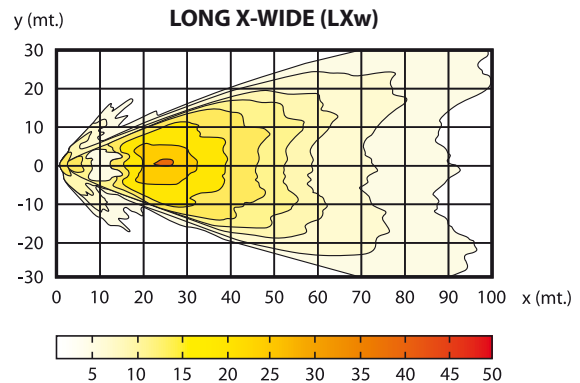
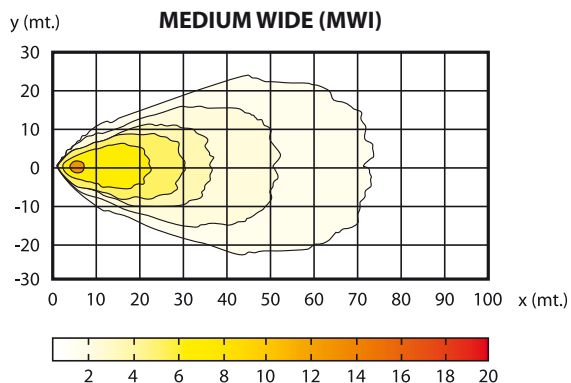

KÓD / ORDER CODE / BESTELL NR. / КОД		POPIS / DESCRIPTION / BESCHREIBUNG / ОПИСАНИЕ	OE / OE NUMBER / OE NUMMER / OE	NÁKRES / DRAWING / ZEICHNUNG / ЧЕРТЁЖ
720554		PRŮCHODKA / GROMMET PG / VERSCHRAUBUNG / ОТВЕРСТИЕ ДЛЯ ПРИСОЕДИНЕНИЯ	05.476.000	
720543		PRŮCHODKA A VYPÍNAČ / GROMMET PG AND SWITCH / VERSCHRAUBUNG UND SCHALTER / ОТВЕРСТИЕ ДЛЯ ПРИСОЕДИНЕНИЯ И ВЫКЛЮЧАТЕЛЬ	05.471.000	
				722909 12V H3 12V 55W, PK22s 722910 24V H3 24V 70W, PK22s



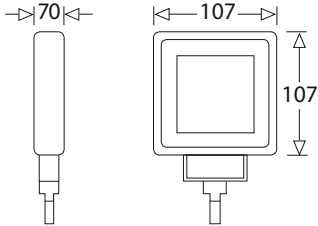

KÓD / ORDER CODE / BESTELL NR. / КОД		POPIS / DESCRIPTION / BESCHREIBUNG / ОПИСАНИЕ	OE / OE NUMBER / OE NUMMER / OE	NÁKRES / DRAWING / ZEICHNUNG / ЧЕРТЁЖ
727138		2PÓLOVÝ KONEKTOR / 2x POLES CONNECTOR / 2x POLE CONTACT / 2 ПОЛЮСНЫЙ ШТЕКЕР	05.1103.0000	
727141		2PÓLOVÝ KONEKTOR, KABEL - 0,2m / 2x POLES CONNECTOR, CABLE - 0,2m / 2x POLE CONTACT, KABEL - 0,2m / 2 ПОЛЮСНЫЙ ШТЕКЕР, КАБЕЛЬ - 0,2м	05.1156.0000	
720019		OPRavnÁ SADA / REPAIR KIT / ANSCHLUSSSATZ / РЕМОНТНЫЙ КОМПЛЕКТ		722909 12V H3 12V 55W, PK22s 722910 24V H3 24V 70W, PK22s

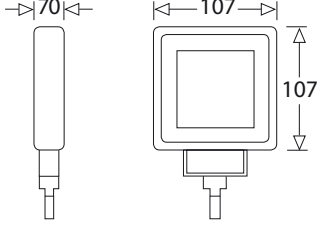

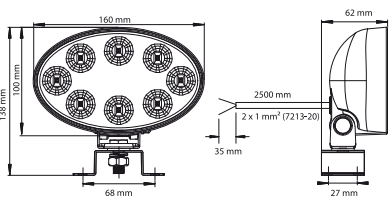





**LED 12-24V PRACOVNÍ SVĚTLOMETY / LED 12-24V WORK LAMPS /
LED 12-24V ARBEITSSCHEINWERFER /
ДИОДНЫЕ 12-24V ФАРЫ РАБОЧЕГО СВЕТА**

KÓD / ORDER CODE / BESTELL NR. / КОД		POPIS / DESCRIPTION / BESCHREIBUNG / ОПИСАНИЕ	OE / OE NUMBER / OE NUMMER / OE	NÁKRES / DRAWING / ZEICHNUNG / ЧЕРТЁЖ
728218	 1300 LUMEN	9-33V LED 9x LED, KABEL - 1,5m / 9x LEADS, CABLE - 1,5m / 9x LEUCHTENDIODEN, KABEL - 1,5m / 9x СВЕТОДИОДНЫЙ, КАБЕЛЬ - 1,5м	LAQ020	
720083	 600 LUMEN	9-33V LED 5x LED, KABEL - 2,5m / 5x LEADS, CABLE - 2,5m / 5x LEUCHTENDIODEN, KABEL - 2,5m / 5x СВЕТОДИОДНЫЙ, КАБЕЛЬ - 2,5м	39-6400-017	
720080	 1560 LUMEN	9-33V LED 10x LED, KABEL - 2,5m / 10x LEADS, CABLE - 2,5m / 10x LEUCHTENDIODEN, KABEL - 2,5m / 10x СВЕТОДИОДНЫЙ, КАБЕЛЬ - 2,5м	38-8200-007	

KÓD / ORDER CODE / BESTELL NR. / КОД		POPIS / DESCRIPTION / BESCHREIBUNG / ОПИСАНИЕ	OE / OE NUMBER / OE NUMMER / OE	NÁKRES / DRAWING / ZEICHNUNG / ЧЕРТЁЖ
720169	 1710 LUMEN LUMINEX	9-33V LED 9x LED, KABEL - 0,35m / 9x LEADS, CABLE - 0,35m / 9x LEUCHTENDIODEN, KABEL - 0,35m / 9x СВЕТОДИОДНЫЙ, КАБЕЛЬ - 0,35м		
720168	 3040 LUMEN LUMINEX	9-33V LED 16x LED, KABEL - 0,35m / 16x LEADS, CABLE - 0,35m / 16x LEUCHTENDIODEN, KABEL - 0,35m / 16x СВЕТОДИОДНЫЙ, КАБЕЛЬ - 0,35м		
720073	 1560 LUMEN LUMINEX	9-33V LED 8x LED, KABEL - 0,35m / 8x LEADS, CABLE - 0,35m / 8x LEUCHTENDIODEN, KABEL - 0,35m / 8x СВЕТОДИОДНЫЙ, КАБЕЛЬ - 0,35м		

KÓD / ORDER CODE / BESTELL NR. / КОД		POPIS / DESCRIPTION / BESCHREIBUNG / ОПИСАНИЕ	OE / OE NUMBER / OE NUMMER / OE	NÁKRES / DRAWING / ZEICHNUNG / ЧЕРТЁЖ
720477		P&R KABEL / P&R CABLE / P&R KABEL / P&R КАБЕЛЬ - 0,5m	68-5000-017	
720478		P&R KABEL / P&R CABLE / P&R KABEL / P&R КАБЕЛЬ - 1 m	68-5000-027	
720474		P&R KABEL / P&R CABLE / P&R KABEL / P&R КАБЕЛЬ - 1,5m	68-5000-037	
720456		P&R KABEL / P&R CABLE / P&R KABEL / P&R КАБЕЛЬ - 0,3m	D10132	
720475		P&R KABEL / P&R CABLE / P&R KABEL / P&R КАБЕЛЬ - 0,5m	68-5000-007	

KÓD / ORDER CODE / BESTELL NR. / КОД		POPIS / DESCRIPTION / BESCHREIBUNG / ОПИСАНИЕ	OE / OE NUMBER / OE NUMMER / OE	NÁKRES / DRAWING / ZEICHNUNG / ЧЕРТЁЖ
721369		7PRAMENNÝ / 7-WIRE / 7-DRAHT / 7 ЖИЛЬНЫЙ	A10042	

KÓD / ORDER CODE / BESTELL NR. / КОД		POPIS / DESCRIPTION / BESCHREIBUNG / ОПИСАНИЕ	OE / OE NUMBER / OE NUMMER / OE	NÁKRES / DRAWING / ZEICHNUNG / ЧЕРТЁЖ		
721459		ADR KABEL - 2x1,5mm, 100m / ADR CABLE - 2x1,5mm, 100m / ADR KABEL - 2x1,5mm, 100m / ADR КАБЕЛЬ - 2x1,5мм, 100м				
721467			9115118			
720472		КРЫТКА КАБЕЛУ / CAP CABLE / DECKEL KABEL / КРЫШКА НА ПРОВОДА	4330012			
721468		P&R / P&R CLICK / P&R KLICKEN / P&R	4260089			

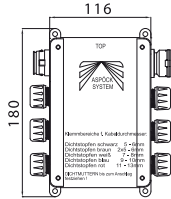
KÓD / ORDER CODE / BESTELL NR. / КОД		POPIS / DESCRIPTION / BESCHREIBUNG / ОПИСАНИЕ	OE / OE NUMBER / OE NUMMER / OE	NÁKRES / DRAWING / ZEICHNUNG / ЧЕРТЁЖ
725417		8 PÓLŮ + ASS 3 + ASS 2 / 8x POLES + ASS 3 + ASS 2 / 8x POLE + ASS 3 + ASS 2 / 8 ПОЛЮСНЫЕ + ASS 3 + ASS 2	76-5123-047	

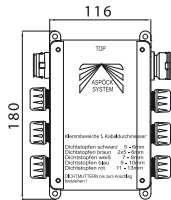
KÓD / ORDER CODE / BESTELL NR. / КОД		POPIS / DESCRIPTION / BESCHREIBUNG / ОПИСАНИЕ	OE / OE NUMBER / OE NUMMER / OE	NÁKRES / DRAWING / ZEICHNUNG / ЧЕРТЁЖ
721733		8 PÓLŮ + ASS 3 / 8x POLES + ASS 3 / 8x POLE + ASS 3 / 8 ПОЛЮСНЫЕ + ASS 3	76-5123-007	

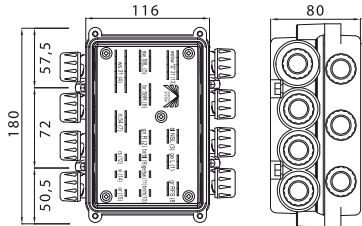
KÓD / ORDER CODE / BESTELL NR. / КОД		POPIS / DESCRIPTION / BESCHREIBUNG / ОПИСАНИЕ	OE / OE NUMBER / OE NUMMER / OE	NÁKRES / DRAWING / ZEICHNUNG / ЧЕРТЁЖ
722069		14 PÓLŮ / 14x POLES / 14x POLE / 14 ПОЛЮСНЫЕ	76-5100-007	

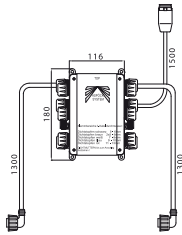
KÓD / ORDER CODE / BESTELL NR. / КОД		POPIS / DESCRIPTION / BESCHREIBUNG / ОПИСАНИЕ	OE / OE NUMBER / OE NUMMER / OE	NÁKRES / DRAWING / ZEICHNUNG / ЧЕРТЁЖ
725415		K ZADNÍ LAMPĚ S ADR KONEKTOREM / WITH LAMP CONNECTION ADR / MIT HECKLEUCHTE-MANSCHLUSS ADR / К ЗАДНЕЙ ЛАМПЕ С ADR ШТЕКЕРЕМ	76-6430-007	

KÓD / ORDER CODE / BESTELL NR. / КОД		POPIS / DESCRIPTION / BESCHREIBUNG / ОПИСАНИЕ	OE / OE NUMBER / OE NUMMER / OE	NÁKRES / DRAWING / ZEICHNUNG / ЧЕРТЁЖ
721790		14 PÓLŮ / 14x POLES / 14x POLE / 14 ПОЛЮСНЫЕ		155x105x85 mm

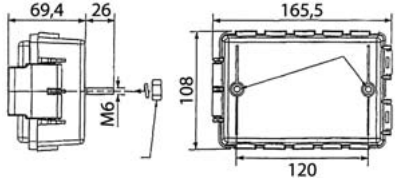
KÓD / ORDER CODE / BESTELL NR. / КОД		POPIS / DESCRIPTION / BESCHREIBUNG / ОПИСАНИЕ	OE / OE NUMBER / OE NUMMER / OE	NÁKRES / DRAWING / ZEICHNUNG / ЧЕРТЁЖ
722062		10 PÓLŮ / 10x POLES / 10x POLE / 10 ПОЛЮСНЫЕ	20.0105.0000.01	

KÓD / ORDER CODE / BESTELL NR. / КОД		POPIS / DESCRIPTION / BESCHREIBUNG / ОПИСАНИЕ	OE / OE NUMBER / OE NUMMER / OE	NÁKRES / DRAWING / ZEICHNUNG / ЧЕРТЁЖ
722070		8 PÓLŮ / 8x POLES / 8x POLE / 8 ПОЛЮСНЫЕ		170x110x70 mm

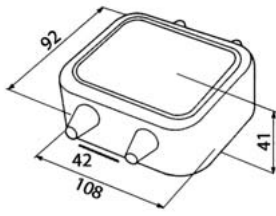
KÓD / ORDER CODE / BESTELL NR. / КОД		POPIS / DESCRIPTION / BESCHREIBUNG / ОПИСАНИЕ	OE / OE NUMBER / OE NUMMER / OE	NÁKRES / DRAWING / ZEICHNUNG / ЧЕРТЁЖ
722073		8 PÓLŮ / 8x POLES / 8x POLE / 8 ПОЛЮСНЫЕ	611090	

ROZVODNÉ SKŘÍŇKY / JUNCTION BOX / VERTEILERBOX / РАЗВОДНЫЕ КОРОБКИ

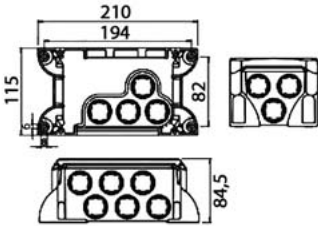
KÓD / ORDER CODE / BESTELL NR. / КОД	POPIS / DESCRIPTION / BESCHREIBUNG / ОПИСАНИЕ	OE / OE NUMBER / OE NUMMER / OE	NÁKRES / DRAWING / ZEICHNUNG / ЧЕРТЁЖ
722077	15 PÓLŮ S ADR / 15x POLES WITH ADR / 15x POLE MIT ADR / 15 ПОЛЮСНЫЕ С ADR	175020	

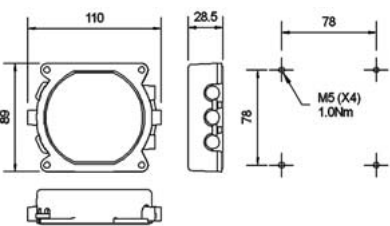
KÓD / ORDER CODE / BESTELL NR. / КОД	POPIS / DESCRIPTION / BESCHREIBUNG / ОПИСАНИЕ	OE / OE NUMBER / OE NUMMER / OE	NÁKRES / DRAWING / ZEICHNUNG / ЧЕРТЁЖ
722064	7 PÓLŮ / 7x POLES / 7x POLE / 7 ПОЛЮСНЫЕ	118 / 01 / 00	

KÓD / ORDER CODE / BESTELL NR. / КОД	POPIS / DESCRIPTION / BESCHREIBUNG / ОПИСАНИЕ	OE / OE NUMBER / OE NUMMER / OE	NÁKRES / DRAWING / ZEICHNUNG / ЧЕРТЁЖ
720113	1x 15 PÓLŮ, 1x N, 1x S / 1x 15 POLES, 1x N, 1x S / 1x 15 POLE, 1x N, 1x S / 1x 15 ПОЛЮСНЫЕ, 1x N, 1x S	24.0263.0000	225 x 1030 x 55 mm 

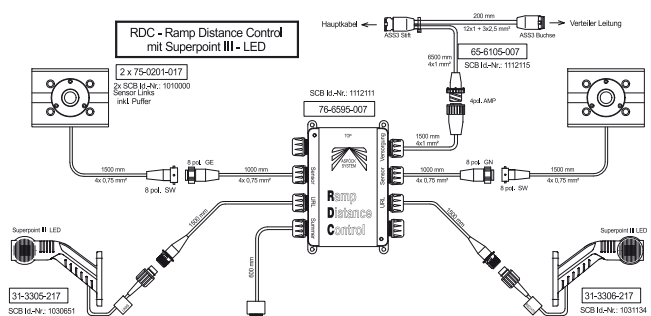
KÓD / ORDER CODE / BESTELL NR. / КОД	POPIS / DESCRIPTION / BESCHREIBUNG / ОПИСАНИЕ	OE / OE NUMBER / OE NUMMER / OE
725365		ROZVODNÝ SYSTÉM SE SUPERPOINTY III. / RDC - RAMP DISTANCE CONTROL WITH SUPERPOINT III. / RDC - RAMP DISTANCE CONTROL MIT SUPERPOINT III. / РАЗВОДЯЩАЯ СИСТЕМА С SUPERPOINTY III.

LED KONTROLNÍ MODULY / LED CONTROLL MODULE / LED KONTROLLE MODUL / ДИОДНЫЕ МОДУЛИ УПРАВЛЕНИЯ

KÓD / ORDER CODE / BESTELL NR. / КОД	POPIS / DESCRIPTION / BESCHREIBUNG / ОПИСАНИЕ	OE / OE NUMBER / OE NUMMER / OE	NÁKRES / DRAWING / ZEICHNUNG / ЧЕРТЁЖ
721735	<p>KONTROLNÍ LED MODUL / THIS LED CONTROL GEAR ADAPTS THE ELECTRICAL CHARACTERISTICS OF LED LIGHTS, TO FIT ON TRUCKS, WHICH ARE NOT COMPATIBLE WITH LEDES UNTIL NOW. / DIESES VORSCHLATGERÄT PASST DEN STROMVERBRAUCH VON LED HECKLEUCHTEN AN DIE BEDÜRFNISSE MODERNER ZUGMASCHINEN AN. / СВЕТОДИОДНЫЙ БЛОК УПРАВЛЕНИЯ</p>	75-0310-001	<p>ASS3 Stift ASS3 male</p> <p>ASS3 Buchse ASS3 female</p> <p>116 mm</p> <p>181 mm</p>

KÓD / ORDER CODE / BESTELL NR. / КОД	POPIS / DESCRIPTION / BESCHREIBUNG / ОПИСАНИЕ	OE / OE NUMBER / OE NUMMER / OE	NÁKRES / DRAWING / ZEICHNUNG / ЧЕРТЁЖ
721736	<p>KONTROLNÍ LED MODUL / THIS LED CONTROL GEAR ADAPTS THE ELECTRICAL CHARACTERISTICS OF LED LIGHTS, TO FIT ON TRUCKS, WHICH ARE NOT COMPATIBLE WITH LEDES UNTIL NOW. / DIESES VORSCHLATGERÄT PASST DEN STROMVERBRAUCH VON LED HECKLEUCHTEN AN DIE BEDÜRFNISSE MODERNER ZUGMASCHINEN AN. / СВЕТОДИОДНЫЙ БЛОК УПРАВЛЕНИЯ</p>	75-0300-007	<p>97</p> <p>80</p> <p>40</p> <p>12,5</p> <p>65,0</p> <p>65,0</p> <p>50</p> <p>50</p>

KÓD / ORDER CODE / BESTELL NR. / КОД	POPIS / DESCRIPTION / BESCHREIBUNG / ОПИСАНИЕ	OE / OE NUMBER / OE NUMMER / OE	NÁKRES / DRAWING / ZEICHNUNG / ЧЕРТЁЖ
721788	<p>KONTROLNÍ LED MODUL 12 V / LED CONTROLL MODULE 12 V / LED KONTROLLE MODUL 12 V / СВЕТОДИОДНЫЙ БЛОК УПРАВЛЕНИЯ 12V</p>		<p>62</p> <p>53,4</p> <p>61,7</p> <p>75,8</p> <p>19,5</p>
721789	<p>KONTROLNÍ LED MODUL 24 V / LED CONTROLL MODULE 24 V / LED KONTROLLE MODUL 24 V / СВЕТОДИОДНЫЙ БЛОК УПРАВЛЕНИЯ 24V</p>		<p>62</p> <p>53,4</p> <p>61,7</p> <p>75,8</p> <p>19,5</p>

**PŘIPOJOVACÍ KABELY / TRAILERS HARNESSES AND ACCESSORIES /
VER KABELUNGSPRODUKTE FÜR ANHÄNGER UND ZUBEHÖR /
СОЕДИНИТЕЛЬНЫЕ КАБЕЛИ**

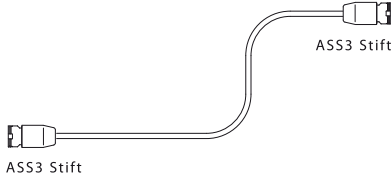
KÓD / ORDER CODE / BESTELL NR. / КОД		POPIS / DESCRIPTION / BESCHREIBUNG / ОПИСАНИЕ	OE / OE NUMBER / OE NUMMER / OE	NÁKRES / DRAWING / ZEICHNUNG / ЧЕРТЁЖ
721917		15 PÓLŮ, 12,5m, 12 x 1 + 3 x 2,5mm / 15 POLES, 12,5m, 12 x 1 + 3 x 2,5mm / 15 POLE, 12,5m, 12 x 1 + 3 x 2,5mm / 15 ПОЛЮСНЫЕ, 12,5м, 12 x 1 + 3 x 2,5мм	65-1007-017	

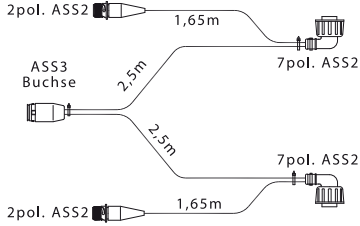
KÓD / ORDER CODE / BESTELL NR. / КОД		POPIS / DESCRIPTION / BESCHREIBUNG / ОПИСАНИЕ	OE / OE NUMBER / OE NUMMER / OE	NÁKRES / DRAWING / ZEICHNUNG / ЧЕРТЁЖ
721918		ADR, ASS3	68-4983-007	

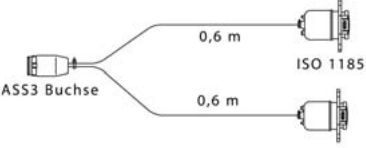
KÓD / ORDER CODE / BESTELL NR. / КОД		POPIS / DESCRIPTION / BESCHREIBUNG / ОПИСАНИЕ	OE / OE NUMBER / OE NUMMER / OE	NÁKRES / DRAWING / ZEICHNUNG / ЧЕРТЁЖ
721922		0,6m, 2 x 7, ASS3	58-6649-007	

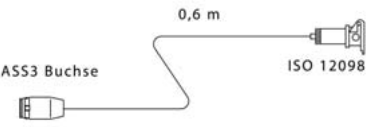
KÓD / ORDER CODE / BESTELL NR. / КОД		POPIS / DESCRIPTION / BESCHREIBUNG / ОПИСАНИЕ	OE / OE NUMBER / OE NUMMER / OE	NÁKRES / DRAWING / ZEICHNUNG / ЧЕРТЁЖ
724146		15 PÓLŮ / 15x POLES / 15x POLE / 15 ПОЛЮСНЫЕ	53-6768-007	

**PŘIPOJOVACÍ KABELY / TRAILERS HARNESSSES AND ACCESSORIES /
VER KABELUNGSPRODUKTE FÜR ANHÄNGER UND ZUBEHÖR /
СОЕДИНИТЕЛЬНЫЕ КАБЕЛИ**

KÓD / ORDER CODE / BESTELL NR. / КОД	POPIS / DESCRIPTION / BESCHREIBUNG / ОПИСАНИЕ	OE / OE NUMBER / OE NUMMER / OE	NÁKRES / DRAWING / ZEICHNUNG / ЧЕРТЁЖ
724145	N+S A 15POLOVÁ ZÁSTRČKA / N+S AND 15 POLES SOCKET / N+S UND 15 POLE STECKER / N+S И 15 ПОЛЮСНЫЕ	58-6647-007	

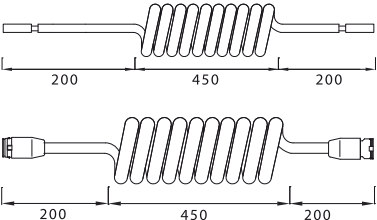

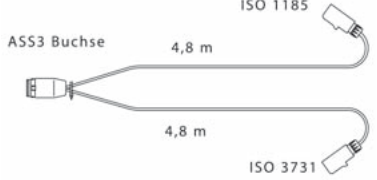

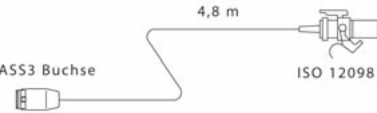











KÓD / ORDER CODE / BESTELL NR. / КОД	POPIS / DESCRIPTION / BESCHREIBUNG / ОПИСАНИЕ	OE / OE NUMBER / OE NUMMER / OE	NÁKRES / DRAWING / ZEICHNUNG / ЧЕРТЁЖ
721785	11 PINŮ, 11 PÓLŮ / 11 PINS, 11 POLES / 11 PIN, 11 POLE / 11 PIN, 11 ПОЛЮСНЫЕ	65-1022-017	

KÓD / ORDER CODE / BESTELL NR. / КОД	POPIS / DESCRIPTION / BESCHREIBUNG / ОПИСАНИЕ	OE / OE NUMBER / OE NUMMER / OE	NÁKRES / DRAWING / ZEICHNUNG / ЧЕРТЁЖ
721914	4,8m A 15PINOVÁ ZÁSUVKA / 4,8m AND 15 PINS PLUG / 4,8m UND 15 PINS STECKER / 4,8м АН + РОЗЕТКА	58-6024-017	

KÓD / ORDER CODE / BESTELL NR. / КОД	POPIS / DESCRIPTION / BESCHREIBUNG / ОПИСАНИЕ	OE / OE NUMBER / OE NUMMER / OE	NÁKRES / DRAWING / ZEICHNUNG / ЧЕРТЁЖ
721915	4,8m A N+S ZÁSUVKA / 4,8m AND N+S PLUG / 4,8m UND N+S STECKER / 4,8м И N+S РОЗЕТКА	53-1667-037	





KÓD / ORDER CODE / BESTELL NR. / КОД		POPIS / DESCRIPTION / BESCHREIBUNG / ОПИСАНИЕ	OE / OE NUMBER / OE NUMMER / OE	NÁKRES / DRAWING / ZEICHNUNG / ЧЕРТЁЖ
723112		ISO 1185 4,5m, N, PLASTOVÝ, 7 PÓLŮ / 4,5m, N, PLASTIC, 7x POLES / 4,5m, N, PLASTIC, 7x POLE / 4,5m, ПЛАСТМАССА, 7 ПОЛЮСНЫЕ		
723114		ISO 3731 4,5m, S, PLASTOVÝ, 7 PÓLŮ / 4,5m, S, PLASTIC, 7x POLES / 4,5m, S, PLASTIC, 7x POLE / 4,5m, С, ПЛАСТМАССА, 7 ПОЛЮСНЫЕ		
723110		ISO 1185 4,5m, N, KOVOVÝ, 7 PÓLŮ / 4,5m, N, METAL, 7x POLES / 4,5m, N, METAL, 7x POLE / 4,5m, N, МЕТАЛЛ, 7 ПОЛЮСНЫЕ		
723111		ISO 3731 4,5m, S, KOVOVÝ, 7 PÓLŮ / 4,5m, S, METAL, 7x POLES / 4,5m, S, METAL, 7x POLE / 4,5m, С, МЕТАЛЛ, 7 ПОЛЮСНЫЕ		
723148		ISO 7368 4,5m, PO, 15 PÓLŮ / 4,5m, PO, 15x POLES / 4,5m, PO, 15x POLE / 4,5m, PO, 15 ПОЛЮСНЫЕ		
723118		ISO 1185 4,5m, 2x7+1x15 PÓLŮ / 4,5m, 2x7+1x15 POLES / 4,5m, 2x7+1x15 POLE / 4,5m, 2x7+1x15 ПОЛЮСНЫЕ		
723116		ISO 7365 4,5m, 5 PÓLŮ, ABS / 4,5m, 5 POLES, ABS / 4,5m, 5 POLE, ABS / 4,5m, 5 ПОЛЮСНЫЕ, ABS		
723182		ISO 4141 4,5m, 7 PÓLŮ, EBS / 4,5m, 7 POLES, EBS / 4,5m, 7 POLE, EBS / 4,5m, 7 ПОЛЮСНЫЕ, EBS		

KÓD / ORDER CODE / BESTELL NR. / КОД		POPIS / DESCRIPTION / BESCHREIBUNG / ОПИСАНИЕ	NÁKRES / DRAWING / ZEICHNUNG / ЧЕРТЁЖ		
723107		ISO 1185 N, PLASTOVÝ / N, PLASTIC / N, PLASTIC / N, ПЛАСТМАССА			
723103		ISO 1185 N, KOVOVÝ / N, METAL / N, METAL / N, МЕТАЛЛ			
723106		ISO 3731 S, PLASTOVÝ / S, PLASTIC / S, PLASTIC / S, ПЛАСТМАССА			
723102		ISO 3731 S, KOVOVÝ / S, METAL / S, METAL / S, МЕТАЛЛ			
723109		ISO 1185 N, PLASTOVÝ / N, PLASTIC / N, PLASTIC / N, ПЛАСТМАССА			
723105		ISO 1185 N, KOVOVÝ / N, METAL / N, METAL / N, МЕТАЛЛ			
723108		ISO 3731 S, PLASTOVÝ / S, PLASTIC / S, PLASTIC / S, ПЛАСТМАССА			
723104		ISO 3731 S, KOVOVÝ / S, METAL / S, METAL / S, МЕТАЛЛ			

KÓD / ORDER CODE / BESTELL NR. / КОД		POPIS / DESCRIPTION / BESCHREIBUNG / ОПИСАНИЕ	OE / OE NUMBER / OE NUMMER / OE	NÁKRES / DRAWING / ZEICHNUNG / ЧЕРТЁЖ
723061		ISO 1185 N, PLASTOVÝ / N, PLASTIC / N, PLASTIC / N, ПЛАСТМАССА		
723101		ISO 1185 N, KOVOVÝ / N, METAL / N, METAL / N, МЕТАЛЛ		
723060		ISO 3731 S, PLASTOVÝ / S, PLASTIC / S, PLASTIC / S, ПЛАСТМАССА		
723100		ISO 3731 S, KOVOVÝ / S, METAL / S, METAL / S, МЕТАЛЛ		
723059		ISO 1185 N, PLASTOVÝ / N, PLASTIC / N, PLASTIC / N, ПЛАСТМАССА		
723093		ISO 1185 N, KOVOVÝ / N, METAL / N, METAL / N, МЕТАЛЛ		
723058		ISO 3731 S, PLASTOVÝ / S, PLASTIC / S, PLASTIC / S, ПЛАСТМАССА		
723090		ISO 3731 S, KOVOVÝ / S, METAL / S, METAL / S, МЕТАЛЛ		



**KABELY - ZÁSUVKY - ZÁSTRČKY / CABLES - PLUG - SOCKET /
KABEL - STECKER - STECKDOSE / КАБЕЛИ - РОЗЕТКИ - ВИЛКИ**



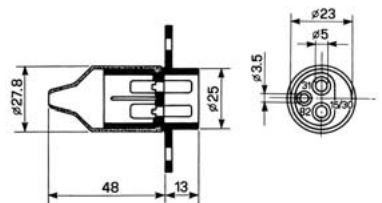
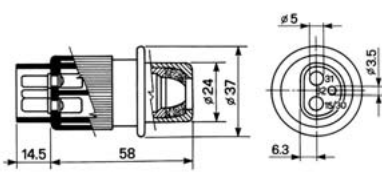

KÓD / ORDER CODE / BESTELL NR. / КОД		POPIS / DESCRIPTION / BESCHREIBUNG / ОПИСАНИЕ	OE / OE NUMBER / OE NUMMER / OE	NÁKRES / DRAWING / ZEICHNUNG / ЧЕРТЁЖ
723072		<p>ISO 7368-1 7 PINŮ / POLŮ, EBS, PLASTOVÝ / 7 PINS / POLES, EBS, PLASTIC / 7 PINS / POLE, EBS, PLASTIC / 7 PIN/ПОЛЮСЫ, EBS, ПЛАСТМАССА</p>		
723138		<p>ISO 7368-1 7 PINŮ / POLŮ, EBS, PLASTOVÝ / 7 PINS / POLES, EBS, PLASTIC / 7 PINS / POLE, EBS, PLASTIC / 7 PIN/ПОЛЮСЫ, EBS, ПЛАСТМАССА</p>		
723080		<p>ISO 7368-1 7 PINŮ / POLŮ, EBS, PLASTOVÝ / 7 PINS / POLES, EBS, PLASTIC / 7 PINS / POLE, EBS, PLASTIC / 7 PIN/ПОЛЮСЫ, EBS, ПЛАСТМАССА</p>		
723140		<p>ISO 7368-1 7 PINŮ / POLŮ, EBS, PLASTOVÝ / 7 PINS / POLES, EBS, PLASTIC / 7 PINS / POLE, EBS, PLASTIC / 7 PIN/ПОЛЮСЫ, EBS, ПЛАСТМАССА</p>		
723077		<p>ISO 7638-1 5 PINŮ / POLŮ, ABS, PLASTOVÝ / 5 PINS / POLES, ABS, PLASTIC / 5 PINS / POLE, ABS, PLASTIC / 5 PIN/ПОЛЮСЫ, ABS, ПЛАСТМАССА</p>		
723135		<p>ISO 7638-1 5 PINŮ / POLŮ, ABS, PLASTOVÝ / 5 PINS / POLES, ABS, PLASTIC / 5 PINS / POLE, ABS, PLASTIC / 5 PIN/ПОЛЮСЫ, ABS, ПЛАСТМАССА</p>		
723081		<p>ISO 7638-1 5 PINŮ / POLŮ, ABS, PLASTOVÝ / 5 PINS / POLES, ABS, PLASTIC / 5 PINS / POLE, ABS, PLASTIC / 5 PIN/ПОЛЮСЫ, ABS, ПЛАСТМАССА</p>		
723137		<p>ISO 7638-1 5 PINŮ / POLŮ, ABS, PLASTOVÝ / 5 PINS / POLES, ABS, PLASTIC / 5 PINS / POLE, ABS, PLASTIC / 5 PIN/ПОЛЮСЫ, ABS, ПЛАСТМАССА</p>		

KÓD / ORDER CODE / BESTELL NR. / КОД		POPIS / DESCRIPTION / BESCHREIBUNG / ОПИСАНИЕ	OE / OE NUMBER / OE NUMMER / OE	NÁKRES / DRAWING / ZEICHNUNG / ЧЕРТЁЖ
723133		ISO 12098 15 PINŮ / POLŮ, PLASTOVÝ / 15 PINS / POLES, PLASTIC / 15 PINS / POLE, PLASTIC / 15 PIN/ПОЛЮСЫ, ПЛАСТМАССА		
723132		ISO 12098 15 PINŮ / POLŮ, PLASTOVÝ / 15 PINS / POLES, PLASTIC / 15 PINS / POLE, PLASTIC / 15 PIN/ПОЛЮСЫ, ПЛАСТМАССА		
723099		ISO 12098 15 PINŮ / POLŮ, PLASTOVÝ / 15 PINS / POLES, PLASTIC / 15 PINS / POLE, PLASTIC / 15 PIN/ПОЛЮСЫ, ПЛАСТМАССА		
723134		ISO 12098 15 PINŮ / POLŮ, PLASTOVÝ / 15 PINS / POLES, PLASTIC / 15 PINS / POLE, PLASTIC / 15 PIN/ПОЛЮСЫ, ПЛАСТМАССА		

KÓD / ORDER CODE / BESTELL NR. / КОД		POPIS / DESCRIPTION / BESCHREIBUNG / ОПИСАНИЕ	OE / OE NUMBER / OE NUMMER / OE	NÁKRES / DRAWING / ZEICHNUNG / ЧЕРТЁЖ
720590		2 x 25 A + 1 x 5 A, 3 PINY / POLY / 2 x 25 A + 1 x 5 A, 3 PINS / POLES / 2 x 25 A + 1 x 5 A, 3 PINS / POLE / 2 x 25 A + 1 x 5 A, 3 PIN/ПОЛЮСЫ	25.036.100.01	
720591		2 x 25 A + 1 x 5 A, 3 PINY / POLY / 2 x 25 A + 1 x 5 A, 3 PINS / POLES / 2 x 25 A + 1 x 5 A, 3 PINS / POLE / 2 x 25 A + 1 x 5 A, 3 PIN/ПОЛЮСЫ	25.036.200.01	

KÓD / ORDER CODE / BESTELL NR. / КОД		POPIS / DESCRIPTION / BESCHREIBUNG / ОПИСАНИЕ	OE / OE NUMBER / OE NUMMER / OE	NÁKRES / DRAWING / ZEICHNUNG / ЧЕРТЁЖ		
723119		<p>ISO 12098 1x15 + 2x7 PINŮ / POLŮ / 1x15 + 2x7 PINS / POLES / 1x15 + 2x7 PINS / POLE / 1x15 + 2x7 PIN/ПОЛЮСЫ</p>				

KÓD / ORDER CODE / BESTELL NR. / КОД		POPIS / DESCRIPTION / BESCHREIBUNG / ОПИСАНИЕ	NÁKRES / DRAWING / ZEICHNUNG / ЧЕРТЁЖ	
726776		4,5 m		M16 x 1,5
726777		4,5 m		M16 x 1,5
726519		6 m		M16 x 1,5
726518		6 m		M16 x 1,5
726778		5 m, PUR		M16 x 1,5
726779		5 m, PA12		M16 x 1,5
726521		4,5 m		M22 x 1,5
726520		4,5 m		M22 x 1,5

KÓD / ORDER CODE / BESTELL NR. / КОД		POPIS / DESCRIPTION / BESCHREIBUNG / ОПИСАНИЕ	NÁKRES / DRAWING / ZEICHNUNG / ЧЕРТЁЖ			
726523		6 m	 M22 x 1,5			
726522		6 m	 M22 x 1,5			

HLINÍKOVÉ NÁRAZNÍKY / ALUMINIUM REAR BUMPER / ALUMINIUM STOSSTANGE / АЛЮМИНЕВЫЕ БАМПЕРЫ









KÓD / ORDER CODE / BESTELL NR. / КОД	POPIS / DESCRIPTION / BESCHREIBUNG / ОПИСАНИЕ	OE / OE NUMBER / OE NUMBER / OE	NÁKRES / DRAWING / ZEICHNUNG / ЧЕРТЁЖ
1 725411	HLINÍKOVÝ NÁRAZNÍK LAKOVANÝ, BÍLÝ / PAINTED, WHITE, INCLUDING PROTECTION CAPS / BEMALT, WEISS, INKL. ENDEKAPPER / АЛЮМИНЕВЫЙ БАМПЕР ЛАКИРОВАННЫЙ, БЕЛЫЙ	14-4164-021	
2 725414	PLASTOVÁ KRYTKA NÁRAZNÍKU, 1 PÁR / PLASTIC COVER FOR REAR BUMPER - 1x PAIR / KUNSTSTOFFABDECKUNG FÜR STOSSTANGE - 1x PAAR / ПЛАСТМАССОВАЯ КРЫШКА БАМПЕРА, 1 ПАРА	15-5394-014	





KÓD / ORDER CODE / BESTELL NR. / КОД	POPIS / DESCRIPTION / BESCHREIBUNG / ОПИСАНИЕ	OE / OE NUMBER / OE NUMBER / OE	NÁKRES / DRAWING / ZEICHNUNG / ЧЕРТЁЖ
1 725404	HLINÍKOVÝ NÁRAZNÍK ELOXOVANÝ / LOOSE ANODISED, INCLUDING PROTECTION CAPS / ELOXIERT LOSE, INKL. ENDEKAPPER / АЛЮМИНЕВЫЙ БАМПЕР С АРТИКОРРОЗИЙНЫМ ПОКРЫТИЕМ	14-4164-001	
2 725414	PLASTOVÁ KRYTKA NÁRAZNÍKU, 1 PÁR / PLASTIC COVER FOR REAR BUMPER - 1x PAIR / KUNSTSTOFFABDECKUNG FÜR STOSSTANGE - 1x PAAR / ПЛАСТМАССОВАЯ КРЫШКА БАМПЕРА, 1 ПАРА	15-5394-014	



**REFLEXNÍ TABULE / REAR MARKER BOARDS /
WARNTAFEL SET / СВЕТОТРАЖАТЕЛИ – ДОСКИ**

KÓD / ORDER CODE / BESTELL NR. / КОД		POPIS / DESCRIPTION / BESCHREIBUNG / ОПИСАНИЕ	OE / OE NUMBER / OE NUMMER / OE	NÁKRES / DRAWING / ZEICHNUNG / ЧЕРТЁЖ
720385		ECE 70.01 1 PÁR / 1x PAIR / 1x PAAR / 1-ПАРА	D10900	197 x 566mm, ALUMINIUM
720387		ECE 70.01 1 KUS / 1x PIECE / 1x STÜCK / 1 ШТ.	D11261	132 x 1132mm, ALUMINIUM
720388		ECE 70.01 1 PÁR / 1x PAIR / 1x PAAR / 1-ПАРА	D10901	197 x 566mm, ALUMINIUM
720389		ECE 70.01 1 KUS / 1x PIECE / 1x STÜCK / 1 ШТ.	D11263	132 x 1132mm, ALUMINIUM



KÓD / ORDER CODE / BESTELL NR. / КОД		POPIS / DESCRIPTION / BESCHREIBUNG / ОПИСАНИЕ	OE / OE NUMBER / OE NUMMER / OE	NÁKRES / DRAWING / ZEICHNUNG / ЧЕРТЁЖ
720391		ECE 70.01 1 PÁR / 1x PAIR / 1x PAAR / 1-ПАРА	D11256	197 x 566mm, REFLEXNÍ FÓLIE / 197 x 566mm, REFLEX REFLECTOR / 197 x 566mm, HAFTRÜCKSTRAHLER / 197 x 566мм, СВЕТОТРАЖАЮЩАЯ ПЛЕНКА
720392		ECE 70.01 1 PÁR / 1x PAIR / 1x PAAR / 1-ПАРА	D11259	197 x 566mm, REFLEXNÍ FÓLIE / 197 x 566mm, REFLEX REFLECTOR / 197 x 566mm, HAFTRÜCKSTRAHLER / 197 x 566мм, СВЕТОТРАЖАЮЩАЯ ПЛЕНКА



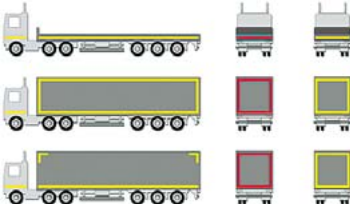
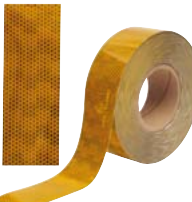
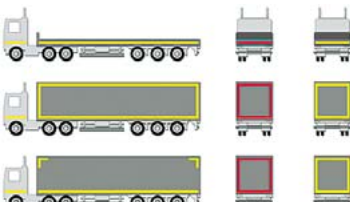

**REFLEXNÍ TABULE / REAR MARKER BOARDS /
WARNTAFEL SET / СВЕТООТРАЖАТЕЛИ – ДОСКИ**

KÓD / ORDER CODE / BESTELL NR. / КОД		POPIS / DESCRIPTION / BESCHREIBUNG / ОПИСАНИЕ	OE / OE NUMBER / OE NUMMER / OE	NÁKRES / DRAWING / ZEICHNUNG / ЧЕРТЁЖ
720380		ECE 70.00 1 PÁR / 1x PAIR / 1x PAAR / 1-ПАРА		197 x 566mm, ALUMINIUM
720379		ECE 70.00 1 PÁR / 1x PAIR / 1x PAAR / 1-ПАРА		197 x 566mm, ALUMINIUM

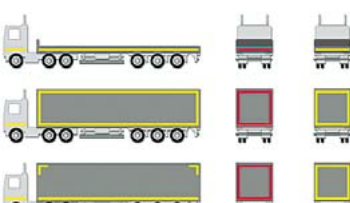
KÓD / ORDER CODE / BESTELL NR. / КОД		POPIS / DESCRIPTION / BESCHREIBUNG / ОПИСАНИЕ	OE / OE NUMBER / OE NUMMER / OE	NÁKRES / DRAWING / ZEICHNUNG / ЧЕРТЁЖ
727185		ECE 70.00 1 PÁR / 1x PAIR / 1x PAAR / 1-ПАРА		197 x 566mm, REFLEXNÍ FÓLIE / 197 x 566 mm, REFLEX REFLECTOR / 197 x 566 mm, HAFTRÜCKSTRAHLER / 197 x 566мм, СВЕТООТРАЖАЮЩАЯ ПЛЕНКА
727186		ECE 70.00 1 PÁR / 1x PAIR / 1x PAAR / 1-ПАРА		197 x 566mm, REFLEXNÍ FÓLIE / 197 x 566 mm, REFLEX REFLECTOR / 197 x 566 mm, HAFTRÜCKSTRAHLER / 197 x 566мм, СВЕТООТРАЖАЮЩАЯ ПЛЕНКА

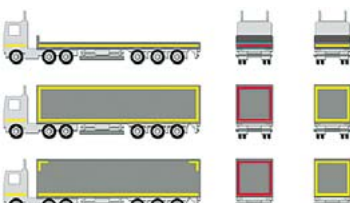
REFLEXNÍ PÁSKY / REFLEX STRIPE / KONTURMARKIERUNG / СВЕТООТРАЖАТЕЛЬНЫЕ ЛЕНТА

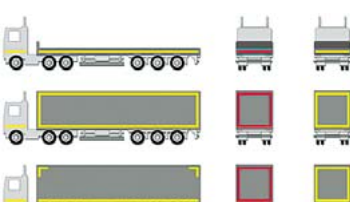
KÓD / ORDER CODE / BESTELL NR. / КОД		POPIS / DESCRIPTION / BESCHREIBUNG / ОПИСАНИЕ	OE / OE NUMBER / OE NUMMER / OE	NÁKRES / DRAWING / ZEICHNUNG / ЧЕРТЁЖ
720476		DĚLKA / LENGTH / LÄNGE / ДЛИНА - 50m		
720484		DĚLKA / LENGTH / LÄNGE / ДЛИНА - 50m		
720483		DĚLKA / LENGTH / LÄNGE / ДЛИНА - 50m		

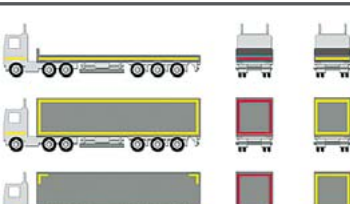
KÓD / ORDER CODE / BESTELL NR. / КОД		POPIS / DESCRIPTION / BESCHREIBUNG / ОПИСАНИЕ	OE / OE NUMBER / OE NUMMER / OE	NÁKRES / DRAWING / ZEICHNUNG / ЧЕРТЁЖ
723414		DĚLKA / LENGTH / LÄNGE / ДЛИНА - 50m		
723410		DĚLKA / LENGTH / LÄNGE / ДЛИНА - 50m		
723416		DĚLKA / LENGTH / LÄNGE / ДЛИНА - 50m		

**REFLEXNÍ PÁSKY / REFLEX STRIPE /
KONTURMARKIERUNG / СВЕТООТРАЖАТЕЛЬНЫЕ ЛЕНТА**

KÓD / ORDER CODE / BESTELL NR. / КОД		POPIS / DESCRIPTION / BESCHREIBUNG / ОПИСАНИЕ	OE / OE NUMBER / OE NUMMER / OE	NÁKRES / DRAWING / ZEICHNUNG / ЧЕРТЁЖ		
720553		1 PÁR / 1x PAIR / 1x PAAR / 1-ПАРА - 2 x 9m	D12020			

**ODRAZKY / REFLEX REFLECTRO /
HAFTRÜCKSTRAHLER / СВЕТОТРАЖАТЕЛИ**

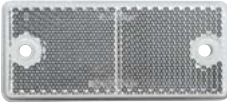
KÓD / ORDER CODE / BESTELL NR. / КОД		POPIS / DESCRIPTION / BESCHREIBUNG / ОПИСАНИЕ	OE / OE NUMBER / OE NUMMER / OE	NÁKRES / DRAWING / ZEICHNUNG / ЧЕРТЁЖ
721355				89 x 39 x 7 mm, ROZTEČ ŠROUBŮ - 70 mm / 89 x 39 x 7 mm, SPACING OF THE BOLTS - 70 mm / 89 x 39 x 7 mm, ABSTAND DER BOLZEN - 70 mm / 89 x 39 x 7 mm, ШАГ РЕЗЬБЫ БОЛТА - 70 мм
721354				89 x 39 x 7 mm, ROZTEČ ŠROUBŮ - 70 mm / 89 x 39 x 7 mm, SPACING OF THE BOLTS - 70 mm / 89 x 39 x 7 mm, ABSTAND DER BOLZEN - 70 mm / 89 x 39 x 7 mm, ШАГ РЕЗЬБЫ БОЛТА - 70 мм
721356				89 x 39 x 7 mm, ROZTEČ ŠROUBŮ - 70 mm / 89 x 39 x 7 mm, SPACING OF THE BOLTS - 70 mm / 89 x 39 x 7 mm, ABSTAND DER BOLZEN - 70 mm / 89 x 39 x 7 mm, ШАГ РЕЗЬБЫ БОЛТА - 70 мм

KÓD / ORDER CODE / BESTELL NR. / КОД		POPIS / DESCRIPTION / BESCHREIBUNG / ОПИСАНИЕ	OE / OE NUMBER / OE NUMMER / OE	NÁKRES / DRAWING / ZEICHNUNG / ЧЕРТЁЖ
726757		TROJÚHELNÍK / TRIANGLE / RÜCKSTRAHLER / ТРЕУГОЛЬНИК		160 x 160 x 160 mm

KÓD / ORDER CODE / BESTELL NR. / КОД		POPIS / DESCRIPTION / BESCHREIBUNG / ОПИСАНИЕ	OE / OE NUMBER / OE NUMMER / OE	NÁKRES / DRAWING / ZEICHNUNG / ЧЕРТЁЖ
726814		TROJÚHELNÍK / TRIANGLE / RÜCKSTRAHLER / ТРЕУГОЛЬНИК		Ø 145 mm, ROZTEČ ŠROUBŮ - 70 mm / Ø 145 mm, BOLTS PITCH - 70 mm / Ø 145 mm, SCHRAUBEN TONNÖHÖE - 70 mm / Ø 145 mm, ШАГ РЕЗЬБЫ БОЛТА - 70 мм

**SIGNALIZACE ZPĚTNÉHO CHODU / BACKUP ALARM /
RÜCKFAHRWARNER / СИГНАЛИЗАЦИЯ ЗАДНЕГО ХОДА**

KÓD / ORDER CODE / BESTELL NR. / КОД		POPIS / DESCRIPTION / BESCHREIBUNG / ОПИСАНИЕ	OE / OE NUMBER / OE NUMMER / OE	NÁKRES / DRAWING / ZEICHNUNG / ЧЕРТЁЖ
727334		12 - 24 V, 86 / 94 DB DRŽÁK DO PRAVÉHO ÚHLU / HOLDER ACCORDING TO ANGLE 90° / HALTER NACH WINKEL 90° / ДЕРЖАТЕЛЬ ПРАВОУГЛОВОЙ		Ø 50mm
721471		12 - 24 V, 87 DB	630120	101 x 67 x 41 mm
727184		24 V, 89 DB / 55 A DRŽÁK DO PRAVÉHO ÚHLU / HOLDER ACCORDING TO ANGLE 90° / HALTER NACH WINKEL 90° / ДЕРЖАТЕЛЬ ПРАВОУГЛОВОЙ	700 / 55 / 24	100 x 58 x 30mm

**BOX NA HASÍČÍ PŘÍSTROJ / FIRE EXTINGUISHER BOX / FEUERLÖSCHER BOX / ЯЩИК ДЛЯ ОГнетушИТЕЛЯ
ZAKLÁDACÍ KLÍN / WHEEL CHOCK / UNTERLEGKEIL / ПОДКЛАДНАЯ КОЛОДКА ПОД КОЛЕСА**

KÓD / ORDER CODE / BESTELL NR. / КОД		POPIS / DESCRIPTION / BESCHREIBUNG / ОПИСАНИЕ	OE / OE NUMBER / OE NUMMER / OE	NÁKRES / DRAWING / ZEICHNUNG / ЧЕРТЁЖ
725756		6 /9kg		670 x 260 x 240mm

KÓD / ORDER CODE / BESTELL NR. / КОД		POPIS / DESCRIPTION / BESCHREIBUNG / ОПИСАНИЕ	OE / OE NUMBER / OE NUMMER / OE	NÁKRES / DRAWING / ZEICHNUNG / ЧЕРТЁЖ
725755				50 x 20 x 23,5 cm

**GUMOVÉ DORAZY / RUBBER BUFFERS /
GUMMIUPFFER / РЕЗИНОВЫЕ БУФЕРЫ**

KÓD / ORDER CODE / BESTELL NR. / КОД		POPIS / DESCRIPTION / BESCHREIBUNG / ОПИСАНИЕ	OE / OE NUMBER / OE NUMMER / OE	NÁKRES / DRAWING / ZEICHNUNG / ЧЕРТЕЖ		
720531				Ø 38 x 30mm		
720556				120 x 55mm		
720558				180 x 55mm		
727354				205 x 20mm		
720557				400 x 80 x 70mm		

ORDER CODE	PAGE
720006	79, 107
720010	78
720015	137
720016	137
720017	55
720019	74, 81, 119, 122, 132, 138
720021	137
720035	69
720045	69
720058	71
720063	31
720072	30
720073	139
720080	139
720083	139
720086	136
720089	136
720100	57
720112	79
720113	144
720120	57
720121	57
720168	139
720169	139
720243	132
720247	26
720248	26
720249	26
720250	137
720251	24
720252	24
720254	88
720255	88
720261	101
720350	31
720351	31
720353	32
720354	32
720355	32
720371	71
720379	158
720380	158
720385	157
720387	157
720388	157
720389	157
720391	157
720392	157
720411	88
720456	140

ORDER CODE	PAGE
720458	108
720460	107
720470	99
720472	141
720474	70, 79, 99, 103, 140
720475	140
720476	159
720477	70, 79, 99, 103, 140
720478	140
720483	159
720484	159
720486	130
720511	34, 35, 36, 37, 38
720512	36
720513	36
720514	35
720515	35
720516	35, 36
720517	35, 36
720531	164
720543	138
720553	160
720554	138
720556	164
720557	164
720558	164
720561	37
720562	37
720590	152
720591	152
720602	37
720603	37
720611	36, 37, 94
720613	36, 37, 94
720785	38, 117
720786	38, 117
720789	38
720790	38
720791	38
721160	34
721161	34
721164	33, 34
721165	33, 34
721166	33
721167	33
721194	58
721195	58
721196	58
721197	58
721198	58

ORDER CODE	PAGE
721223	65
721224	65
721225	65
721226	65
721234	135
721235	135
721262	66
721263	66
721264	66
721265	66
721272	78
721289	85
721302	85
721303	91
721304	102
721306	101
721307	96
721313	107
721314	107
721315	108
721316	108
721319	108
721324	108
721341	95, 96, 98, 101, 106, 113
721342	77
721343	77
721344	96
721345	106
721349	96
721352	106
721354	161
721355	161
721356	161
721358	75
721359	75
721360	111
721361	112
721362	112
721364	94
721365	128
721366	128
721367	128
721368	128
721369	140
721376	95
721381	123
721382	127
721383	101
721384	98
721385	127

ORDER CODE	PAGE
721386	127
721387	127
721388	127
721389	124
721395	113
721419	124
721420	124
721421	124
721422	124
721428	90
721429	90
721430	90
721456	91
721457	91
721458	91
721459	141
721465	71
721466	71
721467	141
721468	40, 41, 70..... 133, 135, 141
721471	162
721481	23
721488	90
721493	22, 29, 42, 43, 44, 45
721501	90, 91
721531	92, 93
721532	92, 93
721549	23
721550	23
721551	23
721552	23
721553	23
721565	107
721566	107
721567	22
721568	22
721569	22
721570	22
721571	22
721572	84
721582	87
721589	83
721594	84
721595	75
721599	74
721602	83
721603	83
721604	83
721607	87
721616	83

ORDER CODE	PAGE
721631	84
721635	87
721636	83
721638	75
721640	84
721646	74
721647	77
721650	77
721652	77
721657	77
721726	67
721730	67
721731	23
721732	23
721733	142
721735	145
721736	39, 40, 41, 145
721737	23
721738	23
721744	133
721754	60
721755	60
721756	60
721757	60
721758	60
721759	60
721760	58, 59, 60, 61, 62, 63, 64, 65, 66
721761	58, 59, 60, 61, 62, 63, 64, 65, 66
721769	53
721770	53
721771	53
721774	53
721776	53
721777	53
721778	53
721779	53
721780	53
721781	53
721785	147
721788	46, 47, 48, 49, 50, 51, 53, 145
721789	42, 43, 44, 45, 46, 47, 48, 49, 50, 51, 52, 53, 145
721790	143
721803	72
721804	85
721805	120
721908	131
721909	131
721914	147

ORDER CODE	PAGE
721915	147
721917	146
721918	146
721922	146
721931	68
721932	68
721933	68
721934	68
721935	68
721945	131
721954	75
721969	95
721970	101
721971	96
721972	110
721973	98
721974	112
722003	27
722004	27
722005	27
722006	27
722007	61
722008	27
722009	61
722010	61
722011	61
722014	62
722015	62
722016	62
722017	63
722019	63
722020	63
722022	63
722023	64
722024	64
722025	64
722026	64
722030	84
722031	84
722036	16
722037	16
722038	18
722039	18
722049	15
722050	15
722051	17
722052	17
722055	15, 16, 17, 18
722056	15, 16, 17, 18
722060	25

ORDER CODE	PAGE
722061	25
722062	143
722063	25
722064	144
722069	142
722070	143
722073	143
722077	144
722115	51
722116	51
722121	52
722124	51
722180	109
722181	109
722221	56
722228	45, 47
722389	129
722391	129
722525	106
722529	100, 105, 111
722549	52
722602	6
722604	6
722607	4
722608	5
722609	5
722610	5, 6, 7, 8
722615	4
722616	9
722617	9
722619	7
722620	7
722621	9, 10
722622	9, 10
722623	3
722624	10
722625	10
722627	9, 10
722628	9, 10
722630	8
722631	8
722632	3
722636	3, 4
722716	24
722718	24
722722	81
722723	80
722724	74
722764	42, 43, 44, 45, 109
722832	74

ORDER CODE	PAGE
722833	74
722837	78
722842	119
722843	122
723040	134
723051	133
723058	150
723059	150
723060	150
723061	150
723072	151
723077	151
723080	151
723081	151
723090	150
723093	150
723099	152
723100	150
723101	150
723102	149
723103	149
723104	149
723105	149
723106	149
723107	149
723108	149
723109	149
723110	148
723111	148
723112	148
723114	148
723116	148
723118	148
723119	153
723132	152
723133	152
723134	152
723135	151
723137	151
723138	151
723140	151
723148	148
723182	148
723410	159
723414	159
723416	159
723705	125
723706	125
723707	125
723708	126

ORDER CODE	PAGE
723709	126
723710	126
723711	126
723712	125
723713	125
723718	126
723719	126
723936	85
723969	111
723970	111
723971	20
723979	20
723980	21
723981	21
723982	70
723983	72
723984	70
723985	70
723986	70
723987	70
723988	85
723989	81
723990	81
723992	99
724018	100
724019	111
724021	121
724024	79
724027	79
724044	103
724045	103
724049	104
724050	106
724051	105
724052	105
724059	81
724112	114
724114	114
724120	105
724123	114
724126	115
724127	115
724130	115
724131	114
724137	115
724139	115
724145	147
724146	146
724147	40, 116
724148	40, 116

ORDER CODE	PAGE
724155	114
724162	114
724167	114
724168	115
724194	133
724195	130
724203	10, 116
724204	10, 116
724206	130
724450	81
724451	81
724688	100
724823	13
724831	13
724832	11
724833	11
724835	12
724836	12
724840	11, 12
724842	13, 14
724846	14
724847	14
724854	39
724855	39
724856	40
724857	40
724860	41
724861	41
724863	20, 21
724864	20, 21
724866	19
724867	19
724868	19
724869	19
724961	75
725145	104
725165	104
725280	79
725365	144
725386	92
725387	92
725404	156
725411	156
725414	156
725415	142
725417	142
725504	19
725505	19
725506	4, 5, 6, 7, 8, 9, 10, 11, 12, 13, 14, 15, 16, 17, 18, 19, 20, 21, 39, 40, 41

ORDER CODE	PAGE
725520	6, 89
725521	6, 89
725522	17, 18, 19, 89
725523	17, 18, 19, 89
725539	100
725540	100
725560	59
725561	59
725562	59
725563	59
725564	59
725654	137
725749	109
725752	97
725755	163
725756	163
725811	43
725812	43
725823	42
725824	42
725954	120
725979	120
725980	48
726006	121
726009	118
726518	154
726519	154
726520	154
726521	154
726522	155
726523	155
726541	133
726548	120
726549	120
726550	112
726554	44
726555	44
726556	45
726557	45
726659	104
726661	99
726664	104
726723	123
726724	123
726725	123
726729	123
726735	48
726736	49
726737	50
726757	161

ORDER CODE	PAGE
726776	154
726777	154
726778	154
726779	154
726814	161
726818	93
726819	93
726820	92
726821	92
726822	93
726823	92
726824	92
726825	92
726857	73, 76, 82, 86
726858	73, 76, 82, 86
726859	73, 76, 82, 86
726860	73, 76, 82, 86
726861	86
726862	73
726864	73
726865	76
726866	86
726867	82
726953	99
726955	105
726956	103
726961	118
726961	121
726962	106
726963	105
726964	121
726965	103
726966	118
726978	106
726983	78
726984	78
726985	78
726992	104
726993	118
726996	104
727009	45, 47
727013	130
727138	138
727141	138
727146	137
727184	162
727185	158
727186	158
727207	88
727235	88

ORDER CODE	PAGE
727236	88
727296	134
727297	134
727326	46
727327	45, 46
727330	125
727334	162

ORDER CODE	PAGE
727335	54
727336	54
727337	54
727348	131
727354	164
727362	28
727363	28

ORDER CODE	PAGE
727364	29
727365	29
727366	28, 29, 30
727379	72
727380	72
727381	87
728218	139

REJSTŘÍK / CROSS REFERENCE LIST / GEGENÜBERSTELLUNG HERSTELLER / СРАВНИТЕЛЬНАЯ ТАБЛИЦА ОРИГИНАЛЬНЫХ НОМЕРОВ

ASPÖCK	ORDER CODE	PAGE
12-1560-001	721931	68
12-1560-011	721932	68
12-1560-021	721935	68
12-1560-031	721934	68
12-1560-041	721933	68
12-1570-001	722628	9, 10
12-1570-101	722627	9, 10
13-0521-044	721760	58, 59, 60, 61, 62, 63, 64, 65, 66
13-0523-044	721761	58, 59, 60, 61, 62, 63, 64, 65, 66
13-5626-951	725506	4, 5, 6, 7, 8, 9, 10, 11, 12, 13, 14, 15, 16, 17, 18, 19, 20, 21, 39, 40, 41
14-4164-001	725404	156
14-4164-021	725411	156
15-2122-104	725165	104
15-5394-014	725414	156
15-5609-107	726961	118, 121
15-5624-024	722525	106
18-8135-007	721303	91
18-8135-027	721501	90, 91
18-8136-007	721531	92, 93
18-8137-007	721532	92, 93
18-8430-007	725563	59
18-8432-107	725564	59
18-8440-007	724863	20, 21
18-8442-007	724864	20, 21
18-8450-007	721755	60
18-8452-007	721759	60
18-8452-107	721757	60
18-8460-007	721198	58
18-8462-107	721197	58
18-8470-007	722009	61
18-8480-007	722016	62
18-8484-007	722022	63
18-8485-007	722026	64
18-8486-007	722020	63
18-8487-007	722025	64
18-8520-002	724842	13, 14
18-8522-002	724840	12
18-8528-002	722056	15, 16, 17, 18
18-8528-502	724868	19
18-8529-002	722055	15, 16, 17, 18
18-8529-502	724869	19
18-8550-002	722636	4
18-8560-002	722610	5, 6, 7, 8
18-8570-001	722622	9, 10
18-8570-101	722621	9, 10
21-2000-004	726978	106
21-2000-045	726962	106
21-2200-004	725145	104

ASPÖCK	ORDER CODE	PAGE
21-3351-707	724123	114, 116
21-3500-004	721488	90
24-3000-007	725560	59
24-3200-007	725561	59
24-3210-007	725562	59
24-4101-007	723979	20
24-4151-007	723981	21
24-4301-007	723971	20
24-4351-007	723980	21
24-5000-007	721754	60
24-5200-007	721758	60
24-5210-007	721756	60
24-6000-007	721194	58
24-6002-507	721196	58
24-6210-007	721195	58
24-6400-507	722609	5
24-7000-007	722011	61
24-7200-007	722010	61
24-7210-007	722007	61
24-8000-007	722015	62
24-8210-007	722014	62
24-8400-007	722019	63
24-8500-007	722024	64
24-8610-007	722017	63
24-8710-007	722023	64
25-2000-507	724831	13
25-2010-507	724847	14
25-2200-007	724833	11
25-2210-007	724835	12
25-2400-507	724823	13
25-2410-507	724846	14
25-2600-007	724832	11
25-2610-007	724836	12
25-2800-507	722050	15
25-2800-517	722037	16
25-2810-507	722052	17
25-2810-517	722039	18
25-2850-517	724866	19
25-2900-507	722049	15
25-2900-517	722036	16
25-2910-507	722051	17
25-2910-517	722038	18
25-2950-517	724867	19
25-3800-507	724854	39
25-3820-517	724856	40
25-3860-517	724860	41
25-3900-507	724855	39
25-3920-517	724857	40
25-3960-517	724861	41
25-5000-507	722615	4

REJSTŘÍK / CROSS REFERENCE LIST / GEGENÜBERSTELLUNG HERSTELLER / СРАВНИТЕЛЬНАЯ ТАБЛИЦА ОРИГИНАЛЬНЫХ НОМЕРОВ

ASPÖCK	ORDER CODE	PAGE
25-5400-507	722607	4
25-6000-507	722608	5
25-6000-707	722631	8
25-6010-507	722619	7
25-6011-517	722604	6
25-6400-707	722630	8
25-6410-507	722620	7
25-6411-517	722602	6
25-7000-507	722617	9
25-7020-507	722625	10
25-7400-507	722616	9
25-7420-507	722624	10
26-3010-004	724195	130
31-2004-017	724051	105
31-2064-017	726955	105
31-2064-037	726963	105
31-2064-217	724120	105
31-2064-717	724052	105
31-2104-017	724050	106
31-2214-017	726956	103
31-2214-037	726965	103
31-2214-117	724044	103
31-2264-017	724045	103
31-2304-017	726992	104
31-2304-037	726996	104
31-2364-017	724049	104
31-2364-087	726659	104
31-2364-107	726664	104
31-2800-007	725386	92
31-2800-027	725387	92
31-2814-007	724027	79
31-2814-047	724024	79
31-3104-007	724204	10, 116
31-3104-017	724203	10, 116
31-3302-027	725523	17, 18, 89
31-3303-027	725522	17, 18, 89
31-3302-037	725504	19
31-3303-037	725505	19
31-3304-047	724114	114
31-3304-057	724112	114
31-3304-067	724127	115
31-3304-077	724126	115
31-3304-087	724168	115
31-3304-097	724167	114
31-3305-067	725521	6, 89
31-3305-237	724148	40, 41, 116
31-3306-067	725520	6, 89
31-3306-237	724147	40, 41, 116
31-3364-007	724131	114
31-3364-017	724137	115

ASPÖCK	ORDER CODE	PAGE
31-3364-027	724155	114
31-3364-037	724130	115
31-3364-047	724139	115
31-3364-057	724162	114
31-3502-087	721429	90
31-3503-087	721429	90
31-3504-107	721456	91
31-3504-167	721456	91
31-4804-037	721603	83
31-4804-047	721604	83
31-5004-007	723984	70
31-5004-087	723982	70
31-5004-097	723985	70
31-5064-027	723986	70
31-5064-067	723987	70
31-6404-017	724019	111
31-6504-087	723983	72
31-6504-107	723988	85
31-6504-177	724059	81
31-6564-067	723989	81
31-6564-077	723990	81
31-6564-147	724450	81
31-6564-157	724451	81
31-6564-237	723936	85
31-6604-077	726953	99
31-6614-037	723992	99
31-6614-077	726661	99
31-6700-027	726993	118
31-6800-017	724021	121
31-6904-017	724018	100
31-6904-037	724688	100
31-7104-007	726966	118
31-7204-007	726964	121
31-7704-017	725540	100
31-7704-037	725539	100
31-7804-017	723969	111
31-7804-057	723970	111
36-3004-017	720486	130
36-3604-007	724194	133
36-3760-017	721234	135
36-3764-017	721235	135
38-8200-007	720080	139
39-6400-017	720083	139
53-1667-037	721915	147
53-6768-007	724146	146
58-6024-017	721914	147
58-6647-007	724145	147
58-6649-007	721922	146
65-1007-017	721917	146
65-1022-017	721785	147

REJSTŘÍK / CROSS REFERENCE LIST / GEGENÜBERSTELLUNG HERSTELLER / СРАВНИТЕЛЬНАЯ ТАБЛИЦА ОРИГИНАЛЬНЫХ НОМЕРОВ

ASPÖCK	ORDER CODE	PAGE
68-4983-007	721918	146
68-5000-007	720475	140
68-5000-017	720477	70, 79, 99, 103, 140
68-5000-027	720478	140
68-5000-037	720474	70, 79, 99, 103, 140
68-5018-024	722529	100, 105, 111
75-0300-007	721736	40, 41, 145

COBO	ORDER CODE	PAGE
02.1082.0000.41	721384	98
02.1083.0000.42	721395	113
02.924.000	720243	132
03.0525.0000.41	721376	95
03.0526.0000.42	721383	101
04.0376.0000.41	721349	96
04.0377.0000.42	721352	106
04.0411.0000.41	721344	96
04.0412.0000.42	721345	106
05.1103.0000	727138	138

HELLA	ORDER CODE	PAGE
2PF001259-631	721803	72
2PS340000-021	721342	77
2PS340001-001	722180	109
2PS962964-012	722723	80
2PS963639-011	722181	109
2SA001259-751	721804	85
2SK340101-011	720072	30
2VA004887-031	722005	27
2VB004887-011	722003	27
2VP003567-111	720248	26
2VP003567-121	720247	26
2VP004887-021	722004	27
2VP340450-021	720354	32
2VP340450-031	720353	32
2VP340450-141	720351	31
2VP340450-151	720350	31
2VP340830-021	720514	35
2VP340830-031	720515	35
2VP340830-101	720512	36
2VP340830-111	720513	36
2VP340930-021	721160	34
2VP340930-031	721161	34
2VP340931-001	721166	33
2VP340931-011	721167	33
2VP340942-101	720562	37
2VP340942-111	720561	37
2VP340961-111	720790	38

ASPÖCK	ORDER CODE	PAGE
75-0310-001	721735	145
76-5100-007	722069	142
76-5123-007	721733	142
76-5123-047	725417	142
76-6430-007	725415	142
99-3010-171	725365	144

COBO	ORDER CODE	PAGE
05.1156.0000	727141	138
05.373.000	727146	137
05.471.000	720543	138
05.476.000	720554	138
20.0105.0000.01	722062	143
24.0263.0000	720113	144
25.0054.0000.01	721341	95, 96, 98, 101, 106, 113
25.036.100.01	720590	152
25.036.200.01	720591	152

HELLA	ORDER CODE	PAGE
2VP340961-121	720789	38
2XS005020-001	721589	83
2XS005020-011	721602	83
2XS005020-021	721616	83
2XS005020-041	721582	87
2XS005020-091	721607	87
2XS011744-011	720786	38, 117
2XS011744-021	720785	38, 117
2XS340827-001	720611	36, 37, 94
2XS340827-011	720613	36, 37, 94
9EL122689-021	720249	26
9EL131420-001	722008	27
9EL131420-011	722006	27
9EL132215-001	721636	83
9EL132215-011	721635	87
9EL152889-001	722063	25
9EL340002-011	721343	77
9EL340201-001	727366	28, 29, 30
9EL340208-001	720355	32
9EL340208-021	720063	31
9EL340829-001	720516	35, 36
9EL340829-011	720517	35, 36
9EL340829-021	721164	33, 34
9EL340829-031	721165	33, 34
9EL340829-051	720602	37
9EL340829-061	720603	37

REJSTŘÍK / CROSS REFERENCE LIST / GEGENÜBERSTELLUNG HERSTELLER / СРАВНИТЕЛЬНАЯ ТАБЛИЦА ОРИГИНАЛЬНЫХ НОМЕРОВ

MAGNETI MARELLI	ORDER CODE	PAGE
LAQ020	728218	139

MERCEDES	ORDER CODE	PAGE
0028207056	721272	78

RUBBOLITE	ORDER CODE	PAGE
118/01/00	722064	144
51/01/01	720058	71
510/01/08	722833	74
510ABS/01/08	722832	74
555/01/00	720371	71
597/01/00	722837	78

RUBBOLITE	ORDER CODE	PAGE
700/55/24	727184	162
810/03/00	725980	48
850/01/04	722842	119
850/02/04	722843	122
TL/97940	720035	69
TL/97944	720045	69

VIGNAL	ORDER CODE	PAGE
001726	725280	79
001846	720490	23
053700	721570	22
053710	721571	22
056700	721552	23
056710	721553	23
087030	721289	85
087040	721359	75
088010	722031	84
104100	720458	108
104130	721304	102
104170	721361	112
104210	721313	107
104250	721314	107
104260	720460	107
104290	720470	99
104330	721360	111
153000	721567	22
153010	721568	22
153020	721569	22
156040	721550	23
156050	721551	23
156060	721549	23
175020	722077	144
178340	721358	75
187730	721302	85
188010	722030	84
193020	720112	79
194010	726985	78
194020	726984	78
194030	726983	78
194130	727380	72
194150	727379	72
194310	727381	87

VIGNAL	ORDER CODE	PAGE
196020	724206	130
198520	721565	107
198540	721566	107
610091	727013	130
611090	722073	143
630120	721471	162
4260089	721468	10, 40, 41..... 133, 135, 141
4330012	720472	141
9115118	721467	141
02070637	721465	71
02077011	721466	71
A10042	721369	140
A10204	721307	96
D10132	720456	140
D10493	721315	108
D10496	721316	108
D10497	721319	108
D10500	721306	101
D10900	720385	157
D10901	720388	157
D11256	720391	157
D11259	720392	157
D11261	720387	157
D11263	720389	157
D11400	721362	112
D12020	720553	160
D12428	721364	94
D12711	721731	23
D12712	721732	23
D13034	721738	23
D13035	721737	23
D13609	721744	133
D13816	726735	48

YOUR LOCAL DEALER

